

# Health Care Waste Management Manual for Ethiopia



April 2021

Addis Ababa, Ethiopia



ጤና ሚኒስቴር - ኢትዮጵያ  
MINISTRY OF HEALTH-ETHIOPIA

የዜጎች ጤና ለሃገር ብልጽግና!  
HEALTHIER CITIZENS FOR PROSPEROUS NATION!

**Health-Care Waste Management Manual**  
**Second Edition**  
**2021**

Hygiene and Environmental Health Directorate of the Federal Ministry of Health (HEHD-FMoH) prepared this Health-care Waste Management Manual for health-care workers and managers in Ethiopia. The document is the revised and updated edition of the first Health-care Waste Guideline published in 2008.

The preparation and publication of this document was made possible through the financial assistance of the World Bank Group

All rights reserved. Subject to the acknowledgement of HEH of FMoH, the Manual may be freely abstracted, reproduced or translated in part or in whole for non-commercial purposes only. If the entire work or substantial portions will be translated or reproduced, permission should be requested from the HEHD-FMoH.

# **Health Care Waste Management Manual for Ethiopia**

**April 2021**

Addis Ababa, Ethiopia

## Acknowledgments

The Hygiene and Environmental Health Directorate of the Federal Ministry of Health (HEHD- FMOH) would like to offer its sincere appreciation to the World Bank Group for their financial and technical support for the development of this manual, which would have been impractical without it.

Starting from the inception to the preparation and production of this manual, several experts from different institutions and organizations have been part of the process. The HEHD-FMOH would like to take this opportunity to express its heartfelt gratitude to all regional health bureau, partner organizations, and Universities. The special thanks go to experts from FMOH, WHO, UNICEF, SNV-Ethiopia, The Ethiopian Environmental Health Professional Association (EEHPA), Jimma University, Wollo University, Hawassa University, and Addis Ababa University for their unreserved technical support during the review of this manual.



**Mrs. Ekram Redwan Hussain**

**Director, Hygiene Environmental Health Directorate, Ministry of Health**

## Preface

Health-care facilities, like every service area in the world, are generating more and more wastes in type and quantity. Health-care wastes can be infectious and contain chemicals or hazardous radioactive substances, which pose a significant risk to the patient, attendants, health-care workers, supportive staff, and the environment. To meet the intended objective of health-care facilities so that patients can receive the required care and recover timely, a safe surrounding is mandatory, which can be attained by proper health-care waste management.

The correct approach for the management of the different types of healthcare wastes generated is not as simple as it seems. Especially in countries like Ethiopia where budget and resources are limited, the selection of the best technology capable of achieving the intended goals of health-care waste management and appropriate for the local conditions needs a thorough attention. Besides, the management of the waste from health-care facilities is complex and to be successful it must be understood and addressed by everyone working in the health-care facility from those cleaning and collecting staffs to the senior experts and administrators. We hope that this manual will equip readers that the management of health-care waste is an essential component of health facilities that must be a priority in health service delivery.

This manual offers the basic knowledge and skills about wastes generated in health service delivery and provides practical recommendations for the use of different techniques of health-care waste management in different contexts. Moreover, it delivers a clear role and responsibility to the different parties within the health-care facilities for the safe management of health-care waste. Though guidance and principles in this manual are up to the standard, it is more appropriate for health-care facilities in Ethiopia and other resources limited countries. Therefore, we hope this manual will convince the waste handlers, waste management experts, health-care workers and administrators that the management of health-care waste is not only an essential component of health-care facilities but it is everyone's responsibility within the health-care facility.

# Contents

<b>Acknowledgments</b>	<b>I</b>
<b>Preface</b>	<b>II</b>
<b>List of Tables</b>	<b>VI</b>
<b>List of Figures</b>	<b>VII</b>
<b>Forward</b>	<b>1</b>
<b>Abbreviation</b>	<b>2</b>
<b>1. Introduction</b>	<b>3</b>
1.1 Background	3
1.2 Objective of the manual	4
1.3 International conventions and Legal aspects of healthcare waste	5
1.3.1 Basel Convention	5
1.3.2 OECD Council Decision	6
1.3.3 Stockholm Convention	6
1.3.4 Minamata Convention	6
1.3.5 The Bamako Convention	7
1.4 Health care waste management in Ethiopia	7
<b>2. Health-care waste definitions, types and sources</b>	<b>10</b>
2.1 Definition	10
2.2 Classification of healthcare wastes	11
2.2.1 Sharps waste	12
2.2.2 Infectious waste	12
2.2.3 Pathological waste	13
2.2.4 Pharmaceutical waste, including genotoxic waste	13
2.2.5 Chemical waste	14
2.2.6 Radioactive waste	16
2.2.7 Non-hazardous general waste	17
2.3 Sources of healthcare wastes	18
<b>3. Environmental and human health risks of health-care waste</b>	<b>20</b>
3.1 Disease transmission	20
3.2 Physical injury	21

3.3 Environmental pollution	22
3.3.1 Air pollution	22
3.3.2 Soil pollution	23
3.3.3 Water pollution	23
3.3.4 Climate change impacts	23
<b>4. Planning, implementing and monitoring health-care waste management</b>	<b>25</b>
4.1 Rationale for planning	25
4.2 Planning HCWM for a national program	27
4.3 HCWM plan at Healthcare facilities and responsibilities of parties	32
4.4 Implementation of HCWM	38
4.5 Monitoring and evaluation	38
<b>5. Health-care waste management principles</b>	<b>40</b>
5.1 Source reduction and minimization	42
5.1.1 Avoiding or prevention	42
5.1.2 Minimization at source	42
5.1.3 Safe and environmentally friendly purchasing	43
5.1.4 Safe reuse	43
5.1.5 Recycling and recovery	45
5.2 Segregation, storage, collection and transportation	46
5.2.1 Segregation	47
5.2.2 HCW Collection	50
5.2.3 On-site Transport of HCW	51
5.2.4 Storage at HCFs	52
5.2.5 Layout of Waste Storage Areas	57
5.2.6 Documentation of Operation in Waste Storage Places	57
5.2.7 Off-site collection	58
5.2.8 Off-site Transport	58
5.3 Treatment and disposal of HCW	59
5.3.1 Overview and selection of methods	59
5.3.2 Waste treatment processes	60
5.3.3 HCW Treatment Technologies	62

5.4 HCW disposal	70
5.4.1 Encapsulation	70
5.4.2 Inertization – Stabilization/Solidification	71
5.4.3 Sharps Pit/Concrete Vault	71
5.4.4 Placenta Pit	72
5.4.5 Safe On-site burial at HCF Located in rural areas	73
5.4.6 Land disposal	74
5.5 Overview of treatment and disposal of HCW in primary care facilities	79
5.6 Management of wastes from home care services	80
5.7 Management of wastes from immunization campaign activities	81
<b>6. Wastewater management in health-care facilities</b>	<b>82</b>
6.1 Composition of HCF Wastewater	82
6.2 Wastewater generation rate in HCFs	82
6.3 Sources and Characteristics of HCF Wastewater	83
6.4 Collection of HCF Wastewater	84
6.5 Treatment of HCF Wastewater	84
6.5.1 Connection to a Municipal/Centralized Wastewater Treatment Plant	85
6.5.2 Pre-treatment of HCF wastewater	85
6.5.3 On-site Wastewater Treatment Plant (WWTP)	86
6.6 Disposal of treated effluent	86
6.7 Disposal of sludge	87
6.8 Basic Wastewater Treatment System for Rural HCF: Minimum requirement for HCFs in Ethiopia	87
6.8.1 Septic tank system	88
6.8.2 Centralized basic system	89
<b>7. Occupational health and safety practices in HCWM</b>	<b>91</b>
7.1 Principles	91
7.2 Occupational Health Risks	92
7.2.1 Cytotoxic Safety	92
7.2.2 Other Health Hazards	92



7.3 Exposure Prevention and Control	94
7.3.1 Hierarchy of Controls for Blood-borne Pathogens	94
7.3.2 HCF Hygiene and Infection Control	99
7.4 Prevention of Nosocomial Infection	99
7.4.1 Standard Precautions	99
7.4.2 Isolation	100
7.4.3 Cleaning	100
7.4.4 Sterilization and disinfection	100
7.5 Occupational Health and Safety Program	101
7.5.1 Immunization	101
7.5.2 Hand Hygiene	101
7.5.3 Education, Communication, Training and Awareness	103
<b>8. Healthcare waste management in emergencies and pandemics</b>	<b>106</b>
8.1 Emergency Management Plan	106
8.1.1 Phase 1: Rapid Initial Assessment	106
8.1.2 Phase 2: Emergency Response	108
8.1.3 Phase 3: Recovery Phase	111
8.2 Contingency Planning and Emergency Preparedness	112
8.3 Emerging Issues	112
8.3.1 Emerging Diseases and Multidrug-resistant Organisms	112
8.3.2 Pandemics	113
8.3.3 Climate Change	117
8.3.4 Other Environmental Issues	118
<b>Annexes</b>	<b>119</b>
<b>References</b>	<b>145</b>

## List of Tables

<b>Table 2.1: Category of health-care waste and their description</b>	<b>11</b>
<b>Table 2. 2: Lists of some major and minor health-care waste sources</b>	<b>18</b>
<b>Table 5. 1: WHO-recommended segregation scheme with container type and color-coding</b>	<b>47</b>
<b>Table 5. 2: Summary of HCW disposal options for each HCW types</b>	<b>76</b>
<b>Table 5. 3: Possible treatment options for HCW</b>	<b>79</b>
<b>Table 6: Sources and characteristics of HCF wastewater</b>	<b>83</b>
<b>Table 7. 1: Summary of hazards and health effects of HCW to health-care workers and their control measures</b>	<b>93</b>
<b>Table 7. 2: Sample PPEs and their specifications for HCW handlers</b>	<b>97</b>
<b>Table 8. 1: Key issues to be addressed in a rapid initial assessment</b>	<b>107</b>
<b>Table 8. 2: Segregation of HCW in emergencies</b>	<b>109</b>
<b>Table 8. 3: Summary of key points relating to environmental issues</b>	<b>118</b>

## List of Figures

<b>Figure 2.1: Waste composition in health-care facilities (WHO, 2014)</b>	<b>10</b>
<b>Figure 4.1: Typical example of HCWM structure in a hospital (WHO, 2014)</b>	<b>34</b>
<b>Figure 5. 1: The waste management hierarchy</b>	<b>40</b>
<b>Figure 5. 2: HCW handling in HCFs – the flow of waste from point of generation to its final disposal</b>	<b>41</b>
<b>Figure 5.3: Recyclable plastics identification codes (ASTM, 2020)</b>	<b>45</b>
<b>Figure 5. 4: Biohazard and radiation hazard (new and old) symbols</b>	<b>48</b>
<b>Figure 5. 5: Safety boxes (sharp containers)</b>	<b>49</b>
<b>Figure 5. 6: Example labelling symbols that can be posted outside the storage facility</b>	<b>54</b>
<b>Figure 5. 7: Example labelling symbols that can be posted inside the storage facility</b>	<b>54</b>
<b>Figure 5. 8: Sample sketch of an HCF waste storage area layout (WHO, 2014)</b>	<b>57</b>
<b>Figure 5. 9: Schematic flow of incineration process (UNEP, 2006)</b>	<b>67</b>
<b>Figure 5. 10: Sample sharp waste concrete vault</b>	<b>72</b>
<b>Figure 5.11: Sample design of placenta pit</b>	<b>73</b>
<b>Figure 6. 1: A sketch of sample two-chambered septic tank (WHO, 2014)</b>	<b>89</b>
<b>Figure 7. 3: The "my five moments of hand hygiene"</b>	<b>103</b>
<b>Figure 8. 1: Procedure for waste disposal in HCF's with a waste autoclave</b>	<b>116</b>
<b>Figure 8. 2: Procedure for waste disposal in HCF's with no waste autoclave</b>	<b>117</b>

## Forward

In the course of delivering the desired health service, health-care services inevitably create waste that may itself be a threat to the health of patients, health-care workers and attendants. Health-care waste produced in Health-care facilities (HCF) carries a higher potential for infection, injury and environmental contamination than most waste types produced in a community. Especially in Ethiopia, with limited waste management facilities and resources, lack of commitment and awareness, the impacts from such wastes could be worse.

As part of the work to address the Hygiene and Environmental health problems in Ethiopia, the Federal Ministry of Health (FMOH) is committed to improving the health-care waste management (HCWM) system in HCFs from the lowest rural health posts to the higher-level hospital and medical centers. Sound management of health-care waste is thus a crucial component of hygiene and environmental health services for the FMOH. In both the short long term, the actions involved in implementing effective health-care waste management programs require multispectral cooperation and interaction at all levels.

Improved public awareness and skill of HCWs in solving the problem of health-care wastes is vital to inspire the health-care workers and waste management staff for a better commitment and practice, and encouraging participation in generating and implementing policies and programs. Management of health-care waste should thus be put into a systematic, multifaceted framework, and should become an integral feature of health-care services. For the effective execution of the health-care waste management practice in the HCFs, knowledge, skills and implementation guideline are key requirements needed besides financial resources. Policies should be generated up to the international standard and must be for the best management practices to be implemented locally. The establishment of a national policy and a legal framework, training of personnel, and raising public awareness are essential elements of successful health-care waste management.

This, health-care waste management is produced with a primary aim to achieve this aim. This manual, the result of efforts from experts of various specialties and experiences, is comprehensive but yet concise and user-friendly and oriented towards practical management of health-care waste in local facilities. It provides technical knowledge and guidelines for the responsible health-care workers, administrators, and waste management staff to offer relevant advice on the management of health-care waste within their facility and at Woreda, zonal, regional or national level.

This health-care waste management manual has been prepared as a practical response to the need for improved health-care waste management in Ethiopia. Therefore, I strongly encourage the widespread distribution and implementation of this manual, and I am ready to assist HCFs and offices in the effective management of health-care waste in the country.

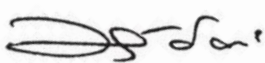

**H.E Dereje Duguma (MD, MPH)**  
State Minister, Ministry of Health

## Abbreviation

<b>APP</b>	Annual Procurement Plan
<b>BAT</b>	Best Available Techniques
<b>BEP</b>	Best Environmental Practices
<b>CEMS</b>	Continuous Emission Monitoring System
<b>DDT</b>	Dichlorodiphenyltrichloroethane
<b>DNA</b>	Deoxyribonucleic Acid
<b>EEHPA</b>	Environmental Health Professionals Association
<b>EIA</b>	Environmental Impact Assessment
<b>EMA</b>	Ethiopian Medical Association
<b>ENA</b>	Ethiopian Nurses Association
<b>EPHA</b>	Ethiopian Public Health Association
<b>FEPA</b>	Federal Environmental Protection Agency
<b>FMHACA</b>	Food, Medicine and Health-care Administration and Control Authority
<b>FMoH</b>	The Federal Ministry of Health
<b>GHG</b>	Greenhouse Gas
<b>GPP</b>	Green Procurement Policy
<b>HAPCO</b>	HIV/AIDS Prevention and Control Office
<b>HBV</b>	Hepatitis B
<b>HCF</b>	Health-care Facilities
<b>HCV</b>	Hepatitis C
<b>HCW</b>	Health-care Waste
<b>HCWM</b>	Health-care Waste Management

<b>HDPE</b>	High-Density Polyethylene Materials
<b>HEPA</b>	High-Efficiency Particulate Air
<b>IEE</b>	Initial Environmental Examination
<b>IPC</b>	Infection Prevention and Control
<b>MSDS</b>	Material Safety Data Sheets
<b>NGOs</b>	Non-Governmental Organizations
<b>OECD</b>	Organization for Economic Co-operation and Development
<b>OIR</b>	Occupational Incident Report
<b>PEP</b>	Post-exposure Prophylaxis
<b>POPs</b>	Persistent Organic Pollutants
<b>PPE</b>	Personal Protective Equipment
<b>PVC</b>	Polyvinyl Chloride
<b>RIA</b>	Radio-Immuno-Assay
<b>SOP</b>	Standard Operating Procedure
<b>UV</b>	Ultraviolet
<b>WHO</b>	World Health Organization
<b>WMP</b>	Waste Management Plan
<b>WWTP</b>	Wastewater Treatment Plant

# 1

## Introduction

### 1.1 Background

It has been widely promoted that every citizen has the right to a clean environment and the right to basic health-care service. The government of Ethiopia has a major concern in providing good quality health services to all the people in the country. The Federal Ministry of Health (FMOH) has adopted various strategies to solve the unrelenting communicable diseases for years throughout the country. Different types of diseases and problems that the country is facing are being solved through different programs by governmental and non-governmental organizations. However, the majority of communicable and emerging infections are still challenging the country's health system. One of the major problems the country is facing is the proper management of waste in general and health-care waste (HCW) in particular. Poor health-care waste management not only affects the waste generators in the health-care facilities but also the waste handlers, the public, and the environment. One of the revealed effects of mishandling of HCW is the alarming incidence of health-care-associated infections and transmission of emerging diseases like COVID 19. Improper treatment and disposal of health-care waste pose serious hazards of secondary disease transmission due to exposures to infectious agents among waste handlers, waste workers, health workers, patients, and the community in general where waste is improperly disposed of.

Though it is still at an early stage in developing countries like Ethiopia, knowledge about the potential for harm from health-care wastes has become more prominent to governments,

medical practitioners, and civil society from time to time. However, managers, medical staff, and waste handlers are expected to take more responsibility for the wastes they produce from their health-care service and related activities than what is done before. The indiscriminate and unreliable handling and disposal of waste within health-care facilities are now widely recognized as a source of avoidable and emerging infection and are synonymous with the public perception of poor standards of health-care.

The process of institutionalization of a good health-care waste management system is complex. It entails a waste assessment and evaluation of existing practices, evaluation of waste management options, development of a waste management plan, endorsement of institutional policies and guidelines, establishment of a waste management organization, allocation of human and financial resources, implementation of plans according to set timelines, as well as a program of periodic training, monitoring, evaluation, and continuous improvement.

During incidences like the ongoing COVID 19 pandemic, countries, cities, and institutions need well-organized tools and an operating waste management system, to cope with surges in health-care waste associated disasters. The best health-care waste management systems not only have a strategy to manage health-care waste generated from routine activities but must also include contingency plans for natural disasters, including pandemics.

Therefore, revising the health-care waste management guideline available at hand to

address new waste types in the health-care facilities, adopt new technologies, exclude outdated systems that might have drawbacks, and respond to emerging issues is vital at this time. The guideline revision is intended for managers of healthcare facilities, policymakers, health professionals, and managers involved in waste management. The guideline, which is upgraded to a manual, addresses aspects such as regulatory framework, planning issues, waste minimization and recycling, handling, storage and transportation, treatment and disposal options, and training.

## 1.2 Objective of the manual

The main objective of this manual is to reduce and control human health and environmental risks, and hazards due to improper HCW by providing technical information and defining the minimum standards for safe and efficient HCWM for Ethiopia. It serves as a tool to protect public health by reducing exposure of HCWs, patients, attendants, other employees of HCFs, and the environment from infectious HCWs in the working environment and beyond.

### **This manual has at least the following specific objectives:**

- Boost compliance of HCWs, waste handlers, and health-care facilities (HCF) managers with regulatory requirements of national and international HCWM guidelines
- Help to design cost-effective HCWM plans and standards, which are protective to human health and the environment, and comply with the current environmental and public health legislation of Ethiopia

### **Enhance community's involvement in HCWM by participating during planning and implementation**

- Boosts the capacity of HCFs to develop suitable HCWM plan and implementation strategy with the available resources
- Helps to set priority actions to tackle the most dangerous problems related to HCWM as part of a global framework.

### **Supports to identify appropriate and sustainable HCW treatment and disposal technologies from minimum**

- Health-care waste management options/standards for various health-care facilities
- Raise awareness of waste generators on waste handling and reduce volumes along with costs without compromising the quality of healthcare

### **Increase employee commitment and morale resulting from a healthier and safer working environment**



## 1.3 International conventions and Legal aspects of healthcare waste

Improvements in HCWM can be achieved through experiences from health-care facilities within a country, which became successful in their implementation. However, impacts from fragmented efforts are hardly ever bringing a significant change. Active government interventions are required to have a nationwide impact in particular and a global impact at large. A national policy should identify the needs and problems in the country, as well as taking into account the relevant international agreements and conventions adopted nationally that govern public health, sustainable development, the environment, and safe management of hazardous waste.

Several international agreements have been reached on many underlying principles, which govern either public health or the safe management of hazardous waste. Ethiopia is one of the signatory countries of various international conventions. Some of the international conventions and agreements which need to be considered during HCWM planning and implementation are discussed briefly below.

### 1.3.1 Basel Convention

The Basel Convention, approved by 170 countries, was adopted in 1989 and came into effect in 1992 as a convention signed on the control of transboundary movements of hazardous wastes and their disposal. Though participating in another legally binding agreement on the transboundary movement of wastes, the U.S is not yet party to the Basel Convention. The central goal of the

Basel Convention is “environmentally sound management” (ESM), the aim of which is to protect human health and the environment by acting on generation, management, transboundary movements, and disposal of hazardous and other wastes, production whenever possible, and trans-boundary movement. HCW is one of the categories of hazardous wastes covered by the convention.

The scope of the Basel convention covers a wide range of wastes defined as “hazardous wastes” based on their origin and/or composition and characteristics. It also addresses two types of wastes categorized as “other wastes” (household waste and incinerator ash). Parties to the Convention may not import waste from, or export waste to, non-parties, except where a separate agreement exists to govern that transboundary movement. Each party is required to introduce appropriate national or domestic legislation to prevent and punish illegal traffic in hazardous and other wastes. Besides, the convention obliges its parties to ensure that hazardous and other wastes are managed and disposed of in an environmentally sound manner.

The Basel Convention specifically refers to clinical wastes from medical care in hospitals, medical centers, and clinics; and pharmaceuticals, drugs, and medicines. The convention also has a category of hazardous characteristics defined as “H 6.2 – Infectious substances – substances or wastes containing viable microorganisms or their toxins which are known or suspected to cause disease in animals or humans.” Besides, the convention has comprehensive technical guidelines on the environmentally sound management of biomedical and health-care wastes.



### 1.3.2 OECD Council Decision

The Organization for Economic Co-operation and Development (OECD) Control System aims at the environmentally sound and economically efficient trade of recyclable materials using a risk-based approach. It comprises the Green Control Procedure and the Amber Control Procedure, which deal with those normally applied in commercial transactions for wastes representing a low risk for human health and the environment, and for wastes presenting sufficient risk to justify their control.

### 1.3.3 Stockholm Convention

The Stockholm Convention is a global agreement adopted in 2001 and entered into enforcement in 2004 international in which the U.S is not one of the parties. This treaty mainly focused on protecting human health and the environment from Persistent Organic Pollutants (POPs). POPs remain intact in the environment for long periods, become widely distributed, accumulate in the fatty tissue of humans and wildlife, and have harmful impacts on human health and the environment. Exposure to POPs can lead to serious health effects including cancers, birth defects, dysfunctional immune and reproductive systems, increased susceptibility to disease, and even diminished intelligence. POPs circulate globally and can cause damage wherever they travel. There are about 22 POPs currently under the control of the convention, which lies in three categories:

- Pesticide-related substances,
- Industrial chemicals (e.g., polychlorinated biphenyls), and
- Unintentionally produced substances (e.g., dioxins and furans).

Article 5 of the Convention requires parties to reduce or eliminate release from the unintentional production of POPs, especially dioxins and furans, which are often produced and released into the air because of the use of health-care waste (HCW) incinerators.

Best environmental practices (BEP) of the convention released in 2006 include source reduction, segregation, resource recovery and recycling, training, and proper collection and transport. The best available techniques (BAT) guidelines for health-care waste incinerators require a combination of specified primary and secondary measures to achieve air emission levels of polychlorinated dibenzo-p-dioxins and dibenzofurans as well as dioxin and furan in specified concentrations of wastewater from the flue gas treatment. The BAT and BEP guidelines of the convention describe alternative technologies such as steam sterilization, advanced steam sterilization, microwave treatment, dry-heat sterilization, alkaline hydrolysis, and biological treatment.

### 1.3.4 Minamata Convention

The Minamata agreement is a specific agreement to protect the effect of one metal, which became legally binding by all parties on 16 August 2017. It is aimed at reducing global mercury pollution by controlling specific human activities that contribute to global mercury pollution. Activities that expose people to mercury include waste incineration, artisanal and small-scale gold mining, operating coal-fired power plants and coal-fired industrial boilers, manufacturing of mercury-containing products (e.g., batteries, lights, cosmetics, medical devices, and dental amalgams), and other manufacturing operations. Article 4 of the convention has

actual significance to healthcare, which calls for the phasing out of mercury-containing products and antiseptics, as well as mercury sphygmomanometers and thermometers used in health-care facilities.

### 1.3.5 The Bamako Convention

The Bamako Convention was negotiated by 12 nations of the Organization of African Unity at Bamako, Mali, in January 1991; and came into force in 1998. The Bamako Convention is a response to Article 11 of the Basel Convention, which encourages parties to enter into bilateral, multilateral, and regional agreements on Hazardous Waste to help achieve the objectives of the convention. The drive for the Bamako convention arose also from the failure of the Basel Convention to prohibit the trade of hazardous waste to less developed countries and the realization that many developed nations were exporting toxic wastes to Africa (Koko case in Nigeria, Probo Koala case in Ivory Coast).

The overall aim of the Bamako convention is to prohibit the import and transboundary movements of all hazardous and radioactive wastes into the African continent for any reason, to prohibit all ocean and inland water dumping or incineration of hazardous wastes, and to ensure that disposal of wastes is conducted in an “environmentally sound manner”. Moreover, it also helps to promote cleaner production over the pursuit of a permissible emissions approach based on assimilative capacity assumptions and establishes the precautionary principle.

## 1.4 Health care waste management in Ethiopia

Ethiopia is the second highly populated country in Africa next to Nigeria. In 2020, the projected Ethiopian population by the United Nations was 114,963,588 with an average growth rate of 2.57%. Though it is not comparable with the rapid population growth, the number of HCFs in the country is increasing from time to time. The FMOH categorizes HCFs within the country as primary, secondary, and tertiary levels based on the type and extent of service delivered. According to data from FMOH, to the end of 2018, the total number of HCFs in service and under construction in Ethiopia are listed below.

- **Hospitals:** 338 available and 218 under construction
- **Health Centers:** 4,063 available and 68 under construction
- **Health Posts:** 17,154 available and 438 under
- **Private Hospitals:** 43
- **Private Clinics:** 3867

The health post, health center, and primary hospitals are intended to serve a population of 3000– 5000, 40000, and 60,000–100,000, respectively. General and specialized hospitals serve 1 to 1.5 and 3.5–5.0 million population, respectively.

## HCW collection practice

A study by Yazie and his colleagues in 2019 showed that the average proportion of HCW from the total waste generated in the HCFs is unacceptably high ranging from 21 to 75%. This is due to the very limited segregation recorded only in very few HCFs. Relatively, privately owned HCFs generated a higher proportion of hazardous wastes than government owned HCFs.

Even in areas where there is limited segregation, there was no use of proper color-coded bins for segregation of the waste, which makes the service inefficient. General and infectious wastes are often found mixed in a waste bin and plastic buckets are regularly used to store the HCW temporarily. Moreover, the disinfection of waste storage and/or transporting utilities was uncommon in most of HCFs.

## HCW treatment and disposal

The common treatment method practiced by HCFs, in all rural areas and mostly in urban, is either open burning or incineration in locally made low-temperature brick incinerators for all waste types. This type of treatment method seldom completely incinerates or disinfect infectious and hazardous wastes. Concerning disposal of the 'treated' wastes and by-products, some studies indicated that burial pit and open dumping in an unsanitary way are common practices everywhere in the country.

## HCWM guidelines and potential challenges in Ethiopia

Unfortunately, the HCWM system in Ethiopia is suffering from various challenges that hinder moving forward as intended. Health-care waste is not only a technical issue but also a management issue, and its safe management should become an integral feature of health-care services. It is indispensable that:

- Awareness and training programs for medical and support staff be strengthened in health-care establishments.
- Appropriate, environmentally friendly, affordable technologies should be selected for the treatment and the disposal of health-care waste, taking into consideration the resources at each health-care facility.

Specific administrative procedures for the management of HCW should be defined.

- Resources and personnel should be allocated at all levels to ensure proper management of health-care waste.
- Individual and team responsibilities with a clear direction of HCWM implementation and monitoring procedures should be established at each level of health-care facilities.

Generally, it is hard to say there is a fully functioning regulation and enforcement specific to the proper management of health-care waste in Ethiopia. There are currently three available HCWM guidelines (including this document) developed by;

- The FMOH,
- Food, medicine and Health-care Administration and Control Authority (FMHACA) and
- Environmental Protection Agency (EPA).

Other global health-care waste management guidelines, especially related to injection safety, have been developed by several partners and stakeholders and used as reference material. Major guidelines for health-care waste management and injection safety have been developed and used by stakeholders include the FMOH, HIV/AIDS prevention and control office (HAPCO), Environmental Protection Authority (EPA), World Health Organization (WHO), United Nations Children’s Fund, Joint United Nations Program on HIV/AIDS and World Bank. Also, non- governmental organizations (NGOs) and cooperating agencies such as INTRA-HEALTH and JHPIEGO, and Professional Associations like Ethiopian Environmental Health Professionals Association (EEHPA), Ethiopian Nurses Association (ENA), Ethiopian Public Health Association (EPHA), Ethiopian Medical Association (EMA), Private Practitioners Association, Ethiopian Pharmacy Association, and Ethiopian Medical Association.

However, the guidelines indicated above do not specifically deal with hazardous waste management in general and health-care waste in particular at the national level except the one by FMOH and WHO. Given the rapid expansion of health-related infrastructure, which implies a rapid growth of health-care

waste generation, the development and implementation of guidelines, directives, and a strategic plan and periodic updating is a forthcoming challenge. Moreover, even the available guideline needs updating since it lacks comprehensiveness to address new risks like COVID 19, new technologies available for efficient implementation not fully functional due to commitment and binding policy for enforcement.

Besides, studies indicated lack of training, awareness, staff resistance, a poor commitment of managers, lack of adequate resources, negligence, and unfavorable attitude of the health-care staff are some of the identified challenges of proper HCWM from experiences.

Some HCFs have started to establish Infection Prevention and Control (IPC) committees. The committees have made important contributions by identifying safety and health problems and by educating the workforce about safety and health issues. Such committees can help to ensure safe work environments in HCFs. This document is therefore prepared to provide technical information and guidelines for the persons involved in health-care waste management at central, regional, district, and local levels as a major upgrade for the HCWM guideline developed by FMOH in 2008.

# 2 Health-care waste definitions, types and sources

## 2.1 Definition

Health-care waste is all the waste generated by health-care facilities, medical laboratories, and biomedical research facilities, as well as waste from minor or scattered sources. Waste generated by health-care activities includes a broad range of materials, from used needles and syringes to soiled dressings, body parts, diagnostic samples, blood, chemicals, pharmaceuticals, medical devices, and radioactive materials. Besides, it includes the same types of infectious or hazardous waste originating from minor and scattered sources, including waste produced in the course of healthcare undertaken in the home.

### The home health-care services may include, but not limited to:

- By-products of chronic disease health-care service like dialysis and self-administration of insulin,
- Wastes from recuperative care for diseases, which can be healed but took a longer time
- Contaminated health-care by-products and domestic materials used at homecare for COVID 19 and similar contagious disease patients

Although health-care facilities produce a huge quantity of waste by volume, a small portion of it is infectious. All wastes generated from services in health-care facilities are not hazardous or infectious wastes. About 75% and 90% of the waste produced by healthcare providers is comparable to domestic waste and usually called “non-hazardous” or “general health-care waste”. General wastes are those, which mostly come from administrative offices, kitchen and housekeeping services at health-care facilities, packaging waste, wastes generated during maintenance of health-care buildings. The remaining 10–25% of health-care waste is regarded as “hazardous” or “infectious” which may result in a variety of human and animal health risks, and environmental problems.

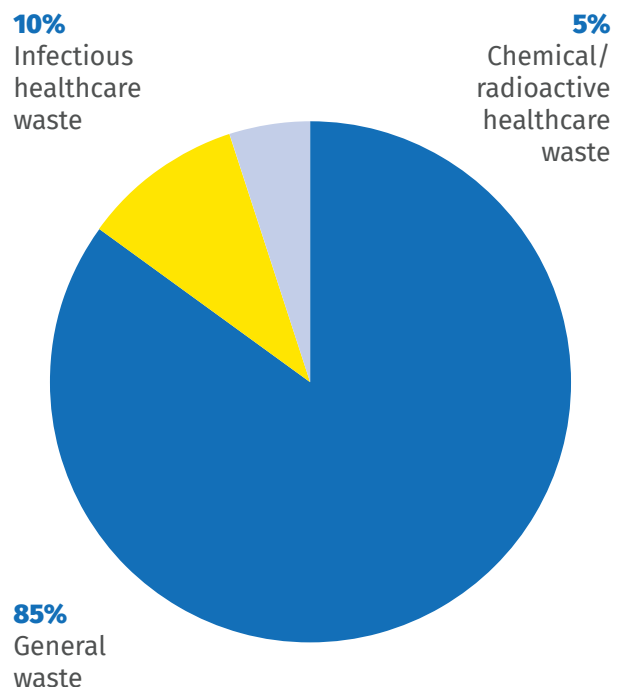

Figure 2.1: Waste composition in health-care facilities (WHO, 2014)

## 2.2 Classification of healthcare wastes

Health-care waste can be put into one of two broad categories: non-hazardous ‘general waste’ and ‘hazardous health-care waste’.

However, the hazardous portion of health-care waste is categorized into Biological and chemical, which is further classified as described in Table 2.1 and discussed in detail in sections 2.2.1 to 2.2.6.

*Table 2.1: Category of health-care waste and their description*

Waste category	Descriptions and examples
<b>Hazardous health-care waste</b>	
<b>Sharps waste</b>	Used or unused sharps (e.g. hypodermic, intravenous or other needles; auto-disable syringes; syringes with attached needles; infusion sets; scalpels; pipettes; knives; blades; broken glass)
<b>Infectious waste</b>	Waste suspected to contain pathogens and that poses a risk of disease transmission. Waste contaminated with blood and other bodily fluids (e.g. from discarded diagnostic samples), cultures and stocks of infectious agents from laboratory work (e.g. waste from autopsies and infected animals from laboratories), or waste from patients with infections (e.g. swabs, bandages, and disposable medical devices)
<b>Pathological waste</b>	Human tissues, organs or fluids; body parts; fetuses; unused blood products, contaminated animal carcasses
<b>Pharmaceutical waste</b>	Pharmaceuticals that are expired, unused, or no longer needed; items contaminated by or containing drugs and vaccines
<b>Cytotoxic waste</b>	Wastes containing substances with genotoxic properties (i.e. highly hazardous substances that are, mutagenic, teratogenic, or carcinogenic), such as cytotoxic drugs used in cancer therapy and their metabolites, and genotoxic chemicals)
<b>Chemical waste</b>	Waste containing chemical substances (e.g. laboratory reagents; film developer; disinfectants that are expired or no longer needed; solvents; waste with a high content of heavy metals, e.g. batteries; mercury in broken thermometers and blood-pressure gauges)
<b>Radioactive waste</b>	Waste containing radioactive diagnostic material or radio-therapeutic materials (e.g. unused liquids from radiotherapy or laboratory research; contaminated glassware, packages or absorbent paper; urine and excreta from patients treated or tested with unsealed radionuclides; sealed sources)
<b>Non-hazardous or general health-care waste</b>	Waste that does not pose any particular biological, chemical, radioactive or physical hazard but which still need attention as in the general waste management

## 2.2.1 Sharps waste

Sharps are items that could cause cuts or puncture wounds, including needles, hypodermic needles, scalpels, and other blades, knives, infusion sets, saws, broken glass, and pipettes. Whether or not they are infected, such items are usually considered highly hazardous health-care waste and should be treated as if they were potentially infected.

## 2.2.2 Infectious waste

Infectious waste is material suspected to contain pathogens (bacteria, viruses, parasites, or fungi) in sufficient concentration or quantity to cause disease in susceptible hosts.

### Infectious category of wastes from HCFs includes:

- waste from surgery and autopsies on patients with infectious diseases (e.g. tissues, and materials or equipment that have been in contact with blood or other body fluids);
- waste from infected patients in isolation wards (e.g. excreta, dressings from infected or surgical wounds, clothes heavily soiled with human blood or other body fluids);
- waste that has been in contact with infected patients undergoing hemodialysis (e.g. dialysis equipment such as tubing and filters, disposable towels, gowns, aprons, gloves, and laboratory coats);
- infected animals from laboratories;
- any other instruments or materials that have been in contact with infected persons or animals.
- waste contaminated with blood or other body fluids of patients in health-care facilities or at home (e.g. medical or domestic materials from COVID 19 patients)
- cultures and stocks of infectious agents from laboratory work

Waste contaminated with blood or other body fluids include free-flowing blood, blood components, and other body fluids; dressings, bandages, swabs, gloves, masks, gowns, drapes, and other material contaminated with blood or other body fluids; and waste that has been in contact with the blood of patients undergoing hemodialysis (e.g. dialysis equipment such as tubing and filters, disposable towels, gowns, aprons, gloves,

and laboratory coats) are considered as infectious wastes

Laboratory cultures and stocks are highly infectious waste. Waste from autopsies, animal bodies, and other waste items that have been inoculated, infected, or in contact with highly infectious agents (based on the World Health Organization's (WHO) Laboratory biosafety manual or other international or national

risk-based classification of pathogens) are highly infectious waste. Discarded instruments or materials that have been in contact with persons or animals infected with highly infectious agents are also to be considered infectious waste.

Waste from infected patients in isolation wards includes excreta, dressings from infected or surgical wounds, and clothes heavily soiled with human blood or other body fluids. Waste from non-infective patients who are not contaminated with blood or body fluids may be considered non-infectious. In low-resource settings, the IPC or medical personnel of the service area should determine whether waste from non-isolation ward patients should be classified as infectious waste.

### **2.2.3 Pathological waste**

Pathological waste could be considered a subcategory of infectious waste but is often classified separately, especially when special methods of handling, treatment, and disposal are used. Pathological waste consists of tissues, organs, body parts, blood, body fluids, and other waste from surgery and autopsies on patients with infectious diseases. It also includes human fetuses and infected animal carcasses. Recognizable human or animal body parts are sometimes called anatomical waste. Pathological waste may include healthy body parts that have been removed during a medical procedure or produced during medical research.

### **2.2.4 Pharmaceutical waste, including genotoxic waste**

Pharmaceutical waste includes expired, unused, spilled, and contaminated

pharmaceutical products, prescribed and proprietary drugs, vaccines, and sera that are no longer required, and, due to their chemical or biological nature, need to be disposed of carefully. The category also includes discarded items heavily contaminated during the handling of pharmaceuticals, such as bottles, vials, and boxes containing pharmaceutical residues, gloves, masks, and connecting tubing.

Genotoxic waste is highly hazardous and may have mutagenic (capable of inducing a genetic mutation), teratogenic (capable of causing defects in an embryo or fetus), or carcinogenic (cancer-causing) properties. The disposal of genotoxic waste should be given special attention because it causes serious safety problems inside hospitals and after disposal. Genotoxic waste may include certain cytostatic drugs (see below), vomit, urine, or faeces from patients treated with cytostatic drugs, chemicals, and radioactive material.

Technically, genotoxic means toxic to the deoxyribonucleic acid (DNA); cytotoxic means toxic to the cell; cytostatic means suppressing the growth and multiplication of the cell; antineoplastic means inhibiting the development of abnormal tissue growth; and chemotherapeutic means the use of chemicals for treatment, including cancer therapy.

Cytotoxic drugs are most often used in specialized departments, such as oncology and radiotherapy units, whose main role is cancer treatment. Their use in other hospital departments and outside the hospital in clinics and elsewhere is also increasing.



**Cytostatic drugs can be categorized as follows:**

- **alkylating agents:** cause alkylation of DNA nucleotides, which leads to cross-linking and miscoding of the genetic stock;
- **antimetabolites:** inhibit the biosynthesis of nucleic acids in the cell;
- **mitotic inhibitors:** prevent cell replication.

**Cytotoxic wastes, which are generated from several sources, can include the following:**

- contaminated materials from drug preparation and administration, such as syringes, needles, gauzes, vials, packaging;
- outdated drugs, excess (leftover) solutions, drugs returned from the wards; urine, feces, and vomit from patients, which may contain potentially hazardous amounts of the administered cytostatic drugs or their metabolites, and which should be considered genotoxic for at least 48 hours and sometimes up to one week after drug administration.

In specialized oncological hospitals, genotoxic waste (containing cytostatic or radioactive substances) may constitute as much as 1% of the total health-care wastes.

Common genotoxic substances, excluding radioactive substances, used in health-care are chemicals like benzene and cytotoxic drugs like azathioprine, chlorambucil, chlornaphazine, ciclosporin, cyclophosphamide, melphalan, semustine, tamoxifen, thiotepa, treosulfan. Besides cytotoxic and other drugs, which possibly or probably classified as carcinogenic are considered in this category. Such drugs, Classified by working groups of the International Agency for Research on Cancer (IARC), include; azacitidine, bleomycin, carmustine, chloramphenicol, chlorozotocin, cisplatin, dacarbazine, daunorubicin, dihydroxymethylfuratrizine (e.g. Panfuran S – no longer in use), doxorubicin, lomustine, methylthiouracil, metronidazole, mitomycin, nafenopin, niridazole, oxazepam, phenacetin, phenobarbital, phenytoin, procarbazine hydrochloride, progesterone, sarcolysin, streptozocin, trichlormethine.

### 2.2.5 Chemical waste

The chemical waste consists of discarded solid, liquid, and gaseous chemicals, for example, from diagnostic and experimental work, cleaning, and disinfecting procedures.

**Chemical waste from healthcare is considered hazardous if it has at least one of the following properties.**

- toxic (harmful)
- corrosive (e.g. acids of pH <2 and bases of pH >12)
- flammable
- reactive (explosive, water-reactive, shock-sensitive)
- oxidizing substances.

Chemical widely used in transfusion liquids waste consists of chemicals with none of the above properties; for example, sugars, amino acids, and certain organic and inorganic salts are considered as non-hazardous chemicals.

The most common types of hazardous chemicals used in health-care centers and hospitals, and the most likely to be found in waste, are described in the following paragraphs.

**Formaldehyde** is a significant source of chemical waste in hospitals. It is used to clean and disinfect equipment (e.g. hemodialysis or surgical equipment); preserve specimens; disinfect liquid infectious waste; and in pathology, autopsy, dialysis, embalming, and nursing units.

**Photographic fixing and developing solutions** are used in X-ray departments where photographic film continues to be used. The fixer usually contains 5–10% hydroquinone, 15% potassium hydroxide, and less than 1% silver. The developer contains approximately 45% glutaraldehyde. Acetic acid is used in both “stop” baths and fixer solutions.

**Wastes containing solvents** are generated in various departments of a hospital, including pathology and histology laboratories and engineering departments. Solvents include halogenated and non-halogenated compounds. Waste organic chemicals generated in health-care facilities include disinfecting and cleaning solutions, vacuum pump and engine oils, insecticides, and

rodenticides. Waste inorganic chemicals consist mainly of acids and alkalis, oxidants, and reducing agents.

Wastes from materials with high heavy-metal contents represent a subcategory of hazardous chemical waste and are usually highly toxic. Mercury is an example of a highly toxic yet common substance in health-care facilities. Mercury wastes are typically generated by spillage from broken clinical equipment, but their volume is decreasing in many countries with the substitution of mercury-free instruments (e.g. digital thermometers, aneroid blood pressure gauges). Whenever possible, spilled drops of mercury should be recovered. Residues from dentistry also have high mercury contents. Cadmium waste comes mainly from discarded batteries and reinforced wood panels containing lead is still used in radiation proofing in X-ray and diagnostic departments, which are highly hazardous to humans and the Environment.

Many types of gas are used in healthcare and are often stored in portable pressurized cylinders, cartridges, and aerosol cans. Many of these are reusable, once empty, or of no further use (although they may still contain residues). However, certain types of aerosol cans are single-use containers that require disposal. Whether inert or potentially harmful, gases in pressurized containers should always be handled with care, containers may explode if incinerated or accidentally punctured.

### Commonly used general classes of chemical waste examples found in health-care facilities are listed below

- **Halogenated solvents:** Chloroform, methylene chloride, perchloroethylene, refrigerants, trichloroethylene
- **Non-halogenated solvents:** Acetone, acetonitrile, ethanol, ethyl acetate, formaldehyde, isopropanol, methanol, toluene, xylenes
- **Halogenated disinfectants:** Calcium hypochlorite, chlorine dioxide, iodine solutions, iodophors, sodium dichloroisocyanurate, sodium hypochlorite (bleach), Aldehydes Formaldehyde, glutaraldehydes, ortho- phthalaldehyde, Alcohols Ethanol, isopropanol, phenols
- **Other disinfectants:** Hydrogen peroxide, peroxyacetic acid, quarternary amines
- **Metals:** Arsenic, cadmium, chromium, lead, mercury, silver
- **Acids:** Acetic, chromic, hydrochloric, nitric, sulfuric
- **Bases:** Ammonium hydroxide, potassium hydroxide, sodium hydroxide
- **Oxidizers:** Bleach, hydrogen peroxide, potassium dichromate, potassium permanganate
- **Reducers:** Sodium bisulfite, sodium sulfite
- **Miscellaneous:** Anaesthetic gases, asbestos, ethylene oxide, herbicides, paints, pesticides, waste oils

### 2.2.6 Radioactive waste

Radioactive waste is defined as material that contains, or is contaminated with, radionuclides at concentrations or activities greater than clearance levels as established by individual countries' regulatory authorities, and for which no use is foreseen. The higher the concentration of radionuclides above established levels the greater the hazard the waste possesses. The hazard of radioactive waste also depends on the nature of the radionuclides and, at the same concentration; different radionuclides have different levels of hazard. This definition of radioactive waste is purely for regulatory purposes. A waste with activity concentrations equal to,

or less than, clearance levels is considered nonradioactive. From a physical viewpoint, however, it is radioactive – although the associated radiological hazards are negligible. Radioactive waste is in part waste like any other, which is nonradioactive. However, radioactive waste may be accompanied by significant levels of radiation hence it requires not only immobilization to prevent radionuclides from spreading around the biosphere, but also shielding and, in some cases, remote handling.

Radioactive wastes in HCFs include materials contaminated with radionuclides, which arise from the medical or research use of radionuclides. These wastes are generated

from in-vitro analysis of body tissue and fluid, in-vivo body organ imaging and tumor localization, and investigative and therapeutic procedures. These wastes with ionizing radiations have genotoxic effects. It is produced during nuclear medicine, radio-immuno-assay (RIA), and bacteriological procedures.

The waste produced by healthcare and research activities involving radionuclides and related equipment maintenance and storage can be classified as follows:

- Sealed sources;
- Spent radionuclide generators;
- Low-level solid waste (e.g. absorbent paper, swabs, glassware, syringes, vials); residues from shipments of radioactive material and unwanted solutions of radionuclides intended for diagnostic or therapeutic use;
- Liquid immiscible with water, such as liquid scintillation counting;
- Residues used in radioimmunoassay, and contaminated pump oil;
- Waste from spills and decontamination of radioactive spills;
- Excreta from patients treated or tested with unsealed radionuclides;
- Low-level liquid waste (e.g. from washing apparatus);
- Gases and exhausts from stores and fume cupboards.

### 2.2.7 Non-hazardous general waste

Non-hazardous HCWs are those wastes generated from the HCFs, which have not been infected or that have not been in contact with infectious agents, hazardous chemicals, or radioactive substances and do not pose a sharps hazard. This type of waste does not pose any problem or hazard to human health

or the environment and is comparable to the domestic waste generated elsewhere. Up to 85% of all waste from health-care facilities is non-hazardous waste and is usually similar in characteristics to municipal solid waste. It is usually generated from the administrative and housekeeping services of HCFs. Examples of such wastes include general office waste, garden/yard waste, packaging, or leftover food. These wastes can be composted to make manure, can be recycled or can be managed by municipal waste services.

#### According to their characteristics for their management, non -hazardous HCWs can be broadly classified as follows:

- **Recyclable HCW:** It includes paper, cardboard, non-contaminated plastic or metal, cans, or glass which can be recycled. These can be sold to the recycling company to generate money besides the waste minimization benefit.
- **Biodegradable HCW:** This category of waste consists of the waste that can be composted. Examples are leftover food scraps or gardens. Food scraps can provide most of the nitrogen while bulking agents such as wood chips could provide carbon. In addition, flowers and plant waste from grounds maintenance are examples of compostable waste. The composting techniques range from simple anaerobic to vermin composting. The resulting rich compost can be used as manure by the community or it can be used for plants in the HCF's surroundings.

- **Other non-risk HCW:** This category of non-risk waste includes all the non-risk waste that does not belong to categories of recyclable HCW and biodegradable HCW.

Moreover, durable goods such as used furniture, bed frames, carpets, curtains, and dishware, as well as computer equipment, printer cartridges, and photocopying toners, are potentially reusable.

## 2.3 Sources of healthcare wastes

The major sources of HCWs are HCFs and other places where health-care services are offered permanently or temporarily. Home-based health services, self-administered medications, emergency health-care services at home, and temporary stations are all

considered sources of HCW. This may include hospitals, emergency medical care services, health-care centers and dispensaries, obstetric and maternity clinics, outpatient clinics, and the like. Other sources are dental clinics, psychiatric hospitals, temporary stations as in COVID 19 isolation and treatment centers, cosmetic ear piercing, and tattoo parlors, illegal drug users.

These HCFs can be viewed as major or minor sources of health-care waste, mainly based on the quantities produced. The major sources of HCW are sources, which produce a large quantity of waste in a given time due to the vast category of services provided while minor and scattered sources produce some health-care waste, but their quantities and composition will vary with some common features. Minor sources rarely produce radioactive or cytostatic wastes, and they did not result in human body parts and sharps.

**Table 2. 2: Lists of some major and minor health-care waste sources**

Major sources	Minor sources
<b>Hospitals</b>	<b>Small healthcare establishments</b>
University hospital	First-aid posts and sick bays
General hospital	Physicians' offices
District hospital	Dental clinics
<b>Other health-care facilities</b>	Acupuncturists
Emergency medical care services	Chiropractors
Health-care centers and dispensaries	<b>Specialized health-care institutions</b>
Obstetric and maternity clinics	Convalescent nursing homes
Outpatient clinics	Psychiatric hospitals
Dialysis centers	Disabled persons 'institutions
Long-term health-care establishments and hospices	<b>Activities involving intravenous or subcutaneous interventions</b>

Major sources	Minor sources
Transfusion centers	Cosmetic ear-piercing and tattoo parlors
Military medical services	Illicit drug users and needle exchanges
Prison hospitals or clinics	<b>Funeral services</b>
<b>Related laboratories and research centers</b>	<b>Ambulance services</b>
Medical and biomedical laboratories	<b>Home treatment</b>
Biotechnology laboratories and institutions	
Medical research centers	
<b>Mortuary and autopsy centers</b>	
<b>Animal research and testing</b>	
<b>Blood banks and blood collection services</b>	
<b>Nursing homes for the elderly</b>	

Sometimes, there may be a situation when it will be difficult to decide whether a waste source can be categorized as hazardous or not. In such a situation, in the absence of clear laws and guidelines, determining the proper classification of specific waste items should be based on an understanding of the principles of disease transmission and

hazardous chemical exposure. The decision significantly depends on the role of the Infection Prevention and Control officer or team at the health-care facility. An item should be considered infectious waste if there is the likelihood that disease transmission could occur during the handling and disposal of the item in question.

**The idea is, for disease transmission to occur; the chain of infection requires one of the following:**

- The presence of pathogens of sufficient virulence and dose,
  - a mode of transmission (e.g. spills or breakage of containers, resulting in skin contact or airborne transmission),
  - a portal of entry (such as an open wound, inhalation, or exposure through the mucous membranes) and
  - a susceptible host (e.g. cleaner, waste worker, scavenger at an open dumpsite).
- Health-care waste generation and quantity

# 3 Environmental and human health risks of health-care waste

Health-care waste management activities can directly affect the environment, human health, and society in a variety of different ways. The potential adverse impacts of inadequate HCWM include disease transmission, physical injury, air pollution, soil pollution, water pollution, climate change, and social impacts. These impacts can result from the improper management and handling of health-care waste during generation, transportation, storage, treatment, and disposal.

All individuals exposed to hazardous health-care wastes are potentially at risk of being injured or infected. Among all, the following are those relatively more affected within the HCFs system and surrounding include:

- **Health service staff:** doctors, pharmacists, laboratory technologists, nurses, paramedics, environmental health officers, and sanitary staff
- **Patients:** People receiving treatment in HCFs and their visitors
- **Workers in support services:** Workers linked to HCFs such as laundries and transportation services
- **Workers in waste management:** cleaners, waste handlers, (in sorting, transportation, and disposal), and scavengers
- **The public:** mostly children playing with the items they find in the waste outside the HCFs when it is directly accessible to them.

More information about these adverse impacts of poor management of HCWs is discussed below.

## 3.1 Disease transmission

Hazardous HCW, including infectious, pathological, and sharps waste, has the potential to contain infectious agents that can transmit diseases to those who encounter it. Infectious agents include bacteria (e.g., cholera and/or E. coli), viruses (e.g., Hepatitis B and/or HIV), and parasites (e.g., giardia and/or lice) that can cause disease transmission in humans or animals. The unsafe disposal of HCWs (for example, contaminated syringes and needles) poses health risks to medical personnel and the public. Contaminated needles and syringes create a big threat if they are not disposed of safely. Contaminated injections and equipment may be scavenged from waste areas and dumpsites and are either reused or sold keeping the public at risk. Experts working on health - care and waste management often complain that the reuse of syringes is certainly one of the most serious problems in developing countries like Ethiopia. In 2014, WHO estimates that about 1.67 million Hepatitis B (HBV) infections, 315,120 cases of Hepatitis C (HCV), and 33,877 HIV infections are associated with unsafe injections. These viruses can remain dormant in the body for a long time before the first symptoms start to appear. Thus, unsafe injections can lead to a silent epidemic that occurs many years after the original unsafe injections that caused the infections.

Individuals exposed to these infectious agents can develop serious and even fatal illnesses. Health-care workers and those handling and managing HCW are at the highest risk

of exposure. Infectious agents can enter the body through punctures, breaks in the skin, inhalation, or ingestion. Providing awareness training to affected workers and using appropriate personal protective equipment (PPE) are important first steps to minimize this risk. There are many documented cases of individuals handling HCW without appropriate PPE and then contracting serious illnesses, including Hepatitis B, HIV/AIDS, or heavy metal poisoning (e.g., due to exposure to mercury from broken thermometers).

If HCW is not segregated, stored, transported, treated, and disposed properly, there is an increased risk of disease transmission for patients, visitors, health-care workers, and the public. Unsegregated, improperly stored, and/or improperly disposed of infectious and sharps waste can spread disease through accidental contact made by health-care workers, patients, or individuals in the local community (e.g., children playing near or in an unsecured HCW burial pit). Another common occurrence in Ethiopia, like many developing countries, is people scavenging in unsecured landfills/burial pits for contaminated, used syringes to re-sell or re-use them. Such people are at high risk for disease transmission. Similarly, foraging animals, both domesticated and feral, are at high risk for disease transmission when not inhibited from entering sites with HCWs or contaminated with it.

Improper HCW incineration can also lead to disease transmission. In most rural HCFs, brick-made local burning structures are used as an incinerator for all health-care wastes including sharps. When infectious waste is not incinerated at the proper temperature, or for an appropriate amount of time, this partial combustion may fail to eliminate the

infectious agents present in the waste. In some cases, it may be safer to manage such wastes using alternative means, rather than through partial combustion. Waste handlers, or others who are exposed to partially combusted waste, may not know the waste is still infectious and are at risk of contracting diseases.

### 3.2 Physical injury

During the handling of wastes (especially infectious and sharps), the medical and support staff as well as the waste management staff can be infected and injured if the waste has not been properly packed. Physical injuries can occur when HCW is poorly managed. Individuals exposed to sharps, including needles, scalpels, razors, or broken glass, are at risk of puncture wounds, severe cuts, abrasions, and increased risk of exposure to pathogens. Examples of improper sharps management include overfilling or not using puncture-proof storage containers, not segregating sharps waste from other waste streams, or handling sharps without proper PPE.

Physical injuries can also occur when chemical waste is improperly handled. Depending on the type of chemical (e.g., corrosive, toxic, and/or reactive), exposed individuals can experience chemical burns, headaches, and/or respiratory illness. One example of a common health-care chemical is formaldehyde. Individuals handling formaldehyde waste without the appropriate PPE can be exposed through inhalation or skin contact. This exposure can cause individuals to experience respiratory irritation, skin irritation, and/or cancer if exposed for longer periods.



Physical injury may also occur when HCW is improperly stored, treated, or disposed. If waste containers are overfilled or become too heavy, individuals transporting or treating the waste may experience back or muscle strain. Workers responsible for the operation of treatment equipment, such as incinerators, compactors, or grinders, can experience physical injuries and respiratory complications if such equipment is not properly operated. Workers handling ash disposal from incinerators without appropriate PPE, for example, can be exposed to physical injuries due to exposure to heavy metals and other toxins contained in the ash.

### 3.3 Environmental pollution

Improper management of HCW does not only affect patients, attendants, and health-care personnel but due consideration must be given to the impact on the environment. Care must be paid to the possible pollution of air, water, and soil, and climate change including the aesthetic beauty. The dumping of HCWs in uncontrolled areas can have a direct environmental effect by contaminating the surroundings including the groundwater. Obsolete pesticides (especially DDT used for the treatment of malaria in HCF), stored in leaking drums or torn bags, can directly or indirectly affect the health of anyone who is exposed to them. Poisoning can occur through direct contact with the product, inhalation of vapors, drinking contaminated water, or consumption of contaminated food. Other hazards may include the possibility of fire because of inefficient disposal such as burning. Pharmaceutical residues, which may include antibiotics and other drugs, heavy metals such as mercury, phenols, and derivatives, and disinfectants and antiseptics may have toxic effects on the

natural ecosystems. The impact of HCW on each environmental compartments including climate change and its social impacts are discussed below.

#### 3.3.1 Air pollution

Air pollution may occur when hazardous HCW, including chemicals, pharmaceuticals, plastics, or heavy metals, are openly burned or incinerated causing particulates, toxic gases, or other pollutants to be released into the air. The use of a continuous emission monitoring system (CEMS), for example, can be used by incinerator operators (or by regulatory agencies, remotely) to help ensure the ongoing environmental compliance of air emissions is in integrity within the HCF. If HCW is landfilled or dumped in an open field like what is currently practiced in Ethiopia, decomposing organic components can release greenhouse gases (GHGs) like methane and carbon dioxide, which are primary contributors to climate change. Air pollution, in the form of toxic fumes, can also occur when containers of certain chemical wastes (e.g., solvents, formaldehyde, and/or alcohols) are left open and the contents allowed to evaporate into the air. Lack of awareness or training for waste handlers and those managing these HCW streams can lead to improper waste segregation and, ultimately, these materials being left in open containers, burned, or incinerated improperly.

Individuals exposed to air pollutants from improper HCW management may have an increased risk of respiratory diseases, cardiovascular diseases, birth defects, and/or cancer. Toxic gases pose a significant health risk to individuals working or living near treatment sites. Air pollution and the associated health risks are greatly increased

when incinerators used to treat HCW are poorly maintained or operated or when unsuitable materials, such as PVC plastics, are burned.

### 3.3.2 Soil pollution

Soil pollution may occur when hazardous HCW, including chemicals, pharmaceuticals, incineration ash, or infectious waste, is disposed of in unlined landfills or pits, accidentally spilled, or stored on permeable ground surfaces. If waste is not properly segregated before incineration, incinerators are not operated properly, or waste is only partially combusted before final disposal, the risk of soil and water pollution is increased.

HCW can accumulate and contaminate the soil over a while, which can then contaminate crops or groundwater and increase the risk of disease transmission, inhibit the growth of plants, or contribute to the degradation of animal habitats. Heavy metals, such as mercury, lead, or cadmium are commonly present in areas where the soil has been contaminated from incinerator ash disposal or other HCW, such as medical devices (e.g., thermometers and/or catheters), batteries used in medical devices, and chemical reagents. Heavy metal contamination of soil can pose a risk of disease and neurological effects for individuals, especially children, who are exposed to the soil.

### 3.3.3 Water pollution

Water pollution may occur when untreated water containing hazardous HCW, including infectious waste and heavy metals, enters surface water or groundwater. Untreated or improperly treated hazardous HCW discharged to the sanitary sewer system

(e.g., via sinks, toilets, and/or floor drains or directly where no sewer systems exist) can ultimately enter surface water bodies, storm drains, ditches, or other conveyances and impact natural surface water bodies (e.g., streams and/or ponds). Illegal dumping of HCW in or near-surface water bodies can also contribute to water pollution. Additionally, the leachate from polluted soil can contaminate groundwater and surface waters.

When HCW is disposed of in low-lying areas, there are chances of waste being leached into the soil and nearby water bodies. The risk of infection increases when wastewater treatment systems and drinking water treatment systems are not equipped to adequately neutralize and remove HCW contaminants (e.g., pharmaceuticals, chemicals, and/or infectious agents) from the effluent. Water contaminated by waste chemicals, pharmaceuticals, or heavy metals can inhibit plant growth and degrade the habitats of water fauna. Individuals exposed to polluted water are at an increased risk of disease transmission and epidemic outbreaks.

### 3.3.4 Climate change impacts

The impacts of climate change have increasingly resulted in new stressors on communities in developing countries, thus creating additional challenges. Strategies for the management of HCW should include efforts to mitigate climate-related risks and vulnerabilities to risks from HCWs.

As discussed in section 3.3.1, waste treatment and disposal practices may generate GHGs either directly (e.g., via waste combustion or burning) or indirectly (e.g., via energy consumption or waste transportation). The

overall climate impact depends on net GHGs. Properly maintained and operated HCWM systems can reduce downstream, indirect GHG emissions through increased recycling and decreased energy and fossil fuel use.

A holistic approach to HCW management may result in positive consequences for GHG emissions. HCW treatment and disposal methods vary in terms of emissions and related environmental impacts. Some options have higher fuel consumption rates or higher emissions to the air or water than others do. These factors are all important to consider during HCWM strategy design and to both mitigate and reduce negative impacts.

Waste segregation and minimization strategies (which are discussed in the chapters later) can help reduce GHG emissions of HCW management activities. Encouraging waste minimization in HCFs results in reduced GHG emissions by, for example, minimizing commodities purchased and, therefore, reducing transportation and disposal needs. The segregation and recovery of nonhazardous paper and organic wastes from hazardous HCW (e.g., to recycle paper, recover pharmaceutical packaging, and compost organics), as well as the associated reduction in the amount of hazardous HCW to manage and treat, can reduce fossil fuel use and avoid increased air emissions.

Additionally, in low-resource or energy-poor HCFs, powering health-care with renewable energy sources, such as solar and wind, can enhance access to health-care services to the community.

### **3.4 Social impacts**

Social impacts are any effect on human health and well-being determinants, such as lifestyle, personal safety, cultural and religious preferences, genetics, social influences, economic conditions, and availability of and access to services and facilities. When HCW is improperly managed, it can lead to adverse social impacts such as increased occupational hazards for health-care workers handling hazardous wastes, increased air pollution for neighboring communities due to improper waste burning, or impact on existing waste management infrastructure due to circumstance increased use of health services. System-wide HCWM, as opposed to project-specific HCWM, can have large-scale social impacts, including the exacerbation of land tenure conflicts and the loss of land used for customary practices, such as when sitting or constructing a new landfill.

# 4 Planning, implementing and monitoring health-care waste management

A comprehensive health-care waste management plan at the national and HCF level is essential for safe and efficient waste management. While developing the waste management plan, the first step is an assessment of the generation rate and types of waste within the facility. The assessment begins with establishing a baseline of how much and what kind of waste is being generated by whom in each department/ward/service area. This involves gathering data regarding the waste streams, processes, and operations, types of practices, information on input materials, and economic information. A waste audit is an important tool for the assessment phase, providing data on the source of waste, compositions, generation rates, and waste flow within the HCF. Data can be collected in-house using self-audit forms and questionnaires. Data collected for few days provides a snapshot of the waste flow and data collected for continuous seven days (eight days collection and discarding the first day) provides a clear picture of waste generation, as the waste generation pattern differs from day to day. Through this data, the HCF can establish the flow of waste and generation rates from every unit of the HCF. Waste composition data can be used to determine segregation practice. Data from the waste generation survey should form the basis while developing the HCWM plan.

## 4.1 Rationale for planning

The primary objective of HCWM is to properly dispose of waste while protecting human health and the environment and ensuring the sustainability of services and activities.

To achieve this objective, health-care services and activities must be designed and implemented with waste management needs and capabilities in mind. Therefore, proper planning for HCWM during the strategy, project, and activity stages are crucial to the sustainability of health-care services at HCFs of various levels.

Proper planning typically requires the development of a system to ensure proper management of HCW, as well as a Waste Management Plan (WMP) or comparable Standard Operating Procedure (SOP) to ensure the effective implementation of the HCW management system. Most importantly, it is wise to make waste management part of a broader set of procedures, such as Infection Prevention Control (IPC) programs. HCW management considerations must also be incorporated into solicitation and award documents to ensure they are given due consideration, including budgeting and planning.

To this end, HCWM operations at local, regional, and national levels should be organized and planned. Haphazard implementation is not the most persuasive or effective way to sustain improvements or to replicate them throughout an HCF or region or country. A good plan is a good basis to explain what needs to be done and to coordinate the roles of the many people involved.

Planning defines the strategy for the implementation of improved waste management and the allocation of roles, responsibilities, and resources. A well-thought-out plan describes the actions to be implemented by authorities, health-care

personnel, and waste workers. At the **national level**, a plan is critical for government to define its intentions to make improvements, and the resources required across the country for successful implementation.

Planning for HCWM at national, regional, or local levels should take into consideration the WHO core principles for achieving safe and sustainable management of health-care waste. The WHO core principles require that all personnel associated with financing and supporting health-care activities should provide for the costs of managing health-care waste. This is the duty of care. Manufacturers also share a responsibility to consider waste management in the development and sale of their products and services.

The core principles guide a clear delineation of responsibilities and funding that takes place essentially at the planning stage.

**Planning should cover the six objectives listed below, drawn from WHO, Basel Convention, and UNEP:**

- a. develop the legal and regulatory framework for health-care waste management
- b. rationalize the waste-management practices within health-care facilities
- c. develop specific financial investment and operational resources dedicated to waste management
- d. launch capacity building and training measures

- e. set up a monitoring plan
- f. reduce the pollution associated with HCWM.

As HCWM is an evolving field, the planning process should allow periodic updates to policies as improvements in processes and technology become known. Plans developed for the local level should be more detailed, with an assessment of needs, difficulties to be overcome, materials needed, skills available, costs, and the waste-handling methods and treatment options available. A local level plan can also be used to explain the benefits of better waste management.

A larger health-care facility should aim to establish a formal waste-management plan. This manual contains the combined knowledge and decisions for all involved in the production, handling, and treatment of HCW. A senior environmental health professional who has better knowledge and experience in HCWM and IPC at a health-care facility should be chosen and made responsible for preparing the plan, collecting ideas from others, and, once agreed, promoting the way health-care waste should be managed to medical and supportive staff. At smaller HCFs, the local plan would be a shorter description of the waste-management arrangements that should be put in place in each health-care service area, as well as identifying who is responsible for good practices in each area, where the waste will go, and how it should be disposed of after it has been removed by a cleaner or porter.

## 4.2 Planning HCWM for a national program

A national management plan should be based on an assessment of the health-care waste-management options available and then reach a consensus on the related actions to be implemented across Ethiopia. A national survey of existing health-care practices and technologies in use should precede a planning exercise. It provides the data to allow realistic plans to be produced that inform government decision-making on the development of new treatment facilities, the regulations and guidance required, and the level of funds necessary to implement a plan at the regional or the country level.

In ideal situations, the national program of health-care waste management can be pursued to give sustained political support and structure to the preparation of a plan for Ethiopia. This is an organized approach involving stakeholders from the health, industry, and public sectors to develop a workable waste policy; provide direction for the preparation of new guidelines and standards for the health sector; reinforce the benefits to public health from controlling wastes and training staff, and indicating the location and design criteria for future waste-treatment and disposal facilities. An exemplifying definition of an action plan by WHO with eight steps explained and described below can be used as a guiding tool of HCWM planning for Ethiopia.

### **Step 1: Establish policy commitment and responsibility for health-care waste management**

Before an action plan is developed and implemented, there needs to be political commitment to prepare a national policy on

healthcare waste management. Thereafter, the responsibility to prepare the plan is delegated to an appropriate government authority. The Ethiopian Federal Ministry of Health Hygiene and Environmental Health Directorate (FMoH-HEHD) is the principal authority to take over the planning activity in collaboration with others, such as ministries and agencies (like EPA) private-sector service providers, law enforcement bodies, nongovernmental organizations (NGOs) and, professional associations. It should be recognized that, at the outset, any policy commitment by a government to improve HCWM will have cost implications, and this should be reflected in the preparation of cost estimates on the financing necessary to fulfill the national plan.

### **Step 2: Conduct a national survey of HCWM practices**

The actual planning and work must be based on what has been done and what is on the ground. Therefore, the responsible body for the issue of health-care waste, FMoH-HEHD, should be fully aware of current levels of waste products and national waste-management practices. To have a clear picture, a survey is essential for planning an effective waste management program. To be comprehensive, data should be collected not only from managers and officials but also from front-line workers. A survey should include both impartial site observations and interviews with environmental health officers, HCF managers, and medical and support staff (e.g. cleaners, waste handlers) at all levels. A standard data collection tool should be prepared to gather data consistently at all or representatively sampled HCFs by FMoH-HEHD. A country-level health-care waste assessment tool by WHO can be found at the following link

[https://www.who.int/water\\_sanitation\\_health/publications/wastemanag/en/](https://www.who.int/water_sanitation_health/publications/wastemanag/en/)

As a guide the assessment tool, at least, should contain the following:

- a. An inventory of existing health facilities**  
– this can be used as a database on the distribution of health-care facilities, the medical services provided, the numbers of patients treated, and the standards of service achieved.
- b. An analysis of existing legislation** – this is crucial for the planning process because it defines the amount and type of legal obligations mandated and highlights any deficiencies in legal and regulatory requirements expected of public bodies, the private sector, and individuals for the safe handling of health-care waste. It is also a point of reference to determine existing responsibilities for waste management and public safety. *For Ethiopia, as a country with deficient regulatory and legal enforcement policies, the analyses are very crucial to fill the gap before or during planning.*
- c. Estimation of national HCW generation**  
– a waste-generation survey provides essential data on the quantities and types of waste produced and a comparison of the rates of generation between health-care facilities and regions. Typical approaches to comparisons between health service areas and health-care waste facilities are to express the waste quantities against the number of hospital beds, bed occupancy rate, or the number of outpatients treated or similar services provided according to the HCFs types per day or month.

- d. Assessment of existing health-care waste-management practices** – In Ethiopia, the unit at the FMOH-HEHD usually do not have clear information on the waste practices in use in hospitals, health centers, and other HCFs at peripheral levels. This information can be gathered by observing staff generating, handling, and managing waste in HCFs. Collecting these data is essential so that real decisions can be made on where to prioritize interventions according to the magnitude of the risks posed by present methods. The kind of qualitative information that can be collected from small HCFs is indicated in the annexed data collection tool (Annex 1).

### Step 3: Develop national guidelines

Technical guidelines are the foundation for a national program of improvement for HCWM, together with a realistic legal framework that supports them. This part consists of the formulation of a *national policy document* based on the results of the national survey, and the identification of new *practical guidance* that needs to be prepared. The two may be brought together in one comprehensive document or addressed separately. The primary responsibility to develop national health-care waste management guidelines in Ethiopia is for FMOH-HEHD in collaboration with others working on this issue.

### Step 4: Formulate a national strategy on HCWM

Drawing on the intentions presented in the national policy, the FMOH-HEHD then must turn its policy objectives into tangible changes within the health-care sector. Commonly, it

requires the ministry of health to develop a national implementation strategy. This national strategy should:

- set goals and the means of monitoring infection control and environmental protection;
- provide an optimal selection of technologies for packaging, transportation, treatment, and disposal;
- identify appropriate options for centralized and local waste-disposal systems;
- reflect the distribution of responsibility in the sector among central, regional, and local authorities;
- propose guidance for training programs at health-care facilities, at municipal, regional, and country levels;
- guide for setting up a monitoring and documentation system on healthcare waste management;
- draw up an action plan for implementing improved waste practices;
- provide a costed investment plan describing the capital, annual operation, and maintenance finance estimated to be needed to implement the national strategy.

#### **Step 5: Develop a policy on regional and cooperative methods of health-care waste treatment**

Ideally, a government should identify the resources needed to build up a national network of disposal facilities for health-care waste, accessible by hospitals and other health-care facilities. Currently, Ethiopia does not have a well-developed, centralized, and technically approved HCW disposal technology.

In general, at present, there are four basic options for managing health-care waste treatment:

**Option 1:** *an onsite treatment facility in each health-care establishment;*

**Option 2:** *regional or cooperative HCW treatment facilities supplemented by individual facilities for remote HCFs*

**Option 3:** *treatment of health-care waste in existing industrial or municipal treatment facilities (e.g. municipal facilities), where these exist;*

**Option 4:** *partial treatment is undertaken on-site, and the remaining waste treated offsite.*

Each option has advantages and disadvantages, and the suitability of each option should be considered in a national plan. A national or regional plan should account for local circumstances, such as the number, location, size and type of health-care establishments, quality of the road network, and financial and technical resources available in each area.

#### **Step 6: Establish legislation: regulations and standards for health-care waste management**

Developing a national HCW plan and guideline by itself does not bring the intended change unless supported by legislation to regulate their application. Waste-management laws are usually based on widely accepted principles contained in various international agreements to which Ethiopia is a signatory (see Section I). However, in Ethiopia, there is no well-developed functional health-care



waste management legislation based on the international agreements signed. Therefore, working with the non-specific common legislation in an application for similar issues is obligatory for the time being.

### **Step 7: Institute a national training program**

To achieve acceptable practices in health-care waste management, all managers and other personnel must receive appropriate training. Besides, training programs are necessary for achieving national health expectations, and for complying with regulations. Developing a health-care waste-management training program could begin with short training for staff and officials, longer courses for staff and officials, longer courses to train future trainers, and refresher courses for experienced staff. Institutions at national, regional, or local levels could assist in preparing *training the trainers* activities and identify competent institutions or centers for the training program. Collaborating with Universities and other academic institutions should be taken into consideration for producing competent graduates during formal University-level studies in Ethiopia. Moreover, partner organizations working on HCW need also to have a similar understanding of the guidelines and policies in application in Ethiopia.

### **Step 8: Review the national health-care waste-management program after implementation**

A national program for health-care waste management should be viewed as a continuous process with periodic monitoring and reassessment by the FMoH-HEHD and other responsible national government agencies, such as public health, sanitation, or environmental agency. Besides, the

recommendations on treatment methods should be regularly updated to keep pace with new developments and international standards. The FMoH-HEHD should base its assessment primarily on reports from hospitals and health centers on their success in implementing waste-management plans. It should review annual reports submitted by the heads of the facilities and make random visits to carry out audits of the waste-management systems. Any deficiencies in the waste-management system should be pointed out to the hospital or health center director in writing, together with recommendations for remedial measures. Where practicable, a time limit for implementing remedial measures should be specified, and the head of the establishment should be informed of the date of a follow-up visit.

Even though there are no established private health-care waste management firms in Ethiopia, when available, offsite waste-treatment facilities, operators of treatment facilities, road-haulage contractors and landfill operators should also be audited. Periodic reviews of waste-management operators by both FMoH-HEHD and the HCFs that use them should be expected. These latter two bodies should also be expected to press for improvements in the protection of occupational and public health from waste operations. Some of the key responsibilities of health offices at the different levels are listed below.

#### **National level**

- The FMoH-HEHD shall take the lead in coordinating the implementation of the HCWM plan.
- The FMoH-HEHD, shall ensure that Regional Health Bureaus (RHBs) prepare and implement a proper HCWM plan.

- The FMOH-HEHD shall support the RHB in the definition and the implementation of the HCWM plan by providing technical advice.
- The FMOH-HEHD shall develop a standardized HCWM training package and set up periodic training program reviews in all the training institutions to ensure that adequate training on HCWM is given.
- The FMOH-HEHD shall be responsible to give supportive supervision on HCWM activities at all levels and at local landfills and other disposal sites to ensure that, treatment and disposal facilities comply with guidance and regulations.
- The FMOH-HEHD and Federal EPA shall plan, implement, and control the means of collection, transportation, destruction, and disposal of the waste.
- The FMOH Health Extension and Education Department shall play a role in activities of public information and awareness-raising on HCWM.
- Environmental Protection Agency (EPA) shall watch over the respect of environmental norms and procedures, particularly as they are contained in the Environmental Impact Assessment guidelines for hazardous wastes and health-care wastes.
- EPA shall develop norms and standards for soil, water, and air pollution, mainly as they relate to the use of landfill sites for HCW disposal. In these conditions, the EPA should develop norms and standards for landfills so that they can safely receive HCW.
- The FMOH-HEHD shall compile HCWM activity reports from RHBs.

### **Regional/zonal/woreda level:**

The regional/zonal/woreda health bureaus/ offices hygiene and environmental health sections shall:

- Prepare and implement a proper regional/ zonal/woreda HCWM plan.
- Give their opinion about the HCWM plan activities proposed for health facilities in their jurisdiction in case some may have negative impacts on the health of the local population.
- Support the HCFs in the definition and the implementation of the HCWM plan by providing technical advice.
- Set up periodic training programs in all the HCFs to ensure that adequate training on HCWM is given to their staff.
- Ensure that coordination of the monitoring and reporting on the implementation of the HCWM will be exercised by the HCWM committee.

Regional capital municipality being with regional health bureau and regional EPA shall:

- Design landfills or equivalent disposal according to the norms and standards defined by the Federal EPA, to avoid soil, water, and air pollution in case of the reception of HCW.
- Ensure safe disposal of HCW by reserving specific areas for disposal sites.
- Enact regulations to refuse to receive mixed HCW with noninfectious wastes at local landfills, forbid uncontrolled HCW disposal, and set up strong waste management controls in their landfills (materials for covering, restriction of unauthorized public access, equipment protection, etc.).

### 4.3 HCWM plan at Healthcare facilities and responsibilities of parties

The effective management of health-care waste is one aspect of the continuous need to control infections. Health-care waste management should be viewed as part of Infection Prevention and Control (IPC), and a local waste-management plan could be developed by IPC staff where they are presently based on the national HCWM plan. In the larger health-care facilities where large quantities of waste are generated, a separate waste-management group or committee may be formed instead. Guidance for facility-level HCWM plan can be referred adaptation at Annex-9.

Typical health-care waste management or an infection prevention and control committee in HCFs may contain the following members depending on the level of the HCF:

- head of the HCF/CEO/Medical directors as chairperson of the committee
- heads of departments from which waste is generated
- environmental health officer
- chief pharmacist
- radiation officer (in hospitals)
- matron (or senior nursing officer)
- administrator/manager
- hospital engineer (in hospitals, if any)
- financial controller
- general service (if one is designated for the HCFs).

In health-care facilities in lower-income areas, the suggested approach is to have a smaller Infection Prevention and Control (IPC) committee with one environmental health officer responsible for HCWM.

The head of HCF should formally appoint the members of the waste-management team in writing, informing each of their duties and responsibilities. The head should appoint a waste management officer who will have overall responsibility for developing the health-care waste-management plan, and for the day-to-day operation and monitoring of the waste-disposal system. Depending on the availability of relevant staff, this post may be assigned preferably to the HCF's environmental health officer, or if not available to environmental/public health engineer together with the HCF administrator/manager, or any other appropriate staff member at the discretion of the head of HCF.

In an institution that is not directly involved in patient care, such as a medical research institution, the head of the establishment should use their discretion to appoint members of the waste-management team from among the relevant staff.

A typical hospital waste-management structure is shown in Figure 4.1, with line-management responsibilities and liaison paths between key personnel involved in handling health-care waste. This structure may be adjusted to the particular needs of each HCF. Key personnel in HCFs can share duties (as described in the following paragraphs), while one person can fulfill two or more sets of responsibilities in smaller health-care facilities.

## **i. Head/CEO/Medical director**

The head of HCF is responsible for the following tasks:

- **Form a waste-management team to develop a written waste-management plan for the HCF.**

The team should consist of representatives from clinical and non-clinical areas of the organization, in addition to those who are involved in the removal and management of waste. The plan should clearly define the duties and responsibilities of all members of staff, both clinical and non-clinical, concerning handling health-care waste and establish lines of accountability.

- **Oversee and approve a waste-management plan.**

Designate a waste-management officer (an environmental health officer) to supervise and implement the waste management plan. The head of HCF retains overall responsibility for ensuring that healthcare and other wastes are disposed of according to national guidelines.

- **Keep the waste-management plan updated by setting regular (e.g. annual) review dates.**

Allocate financial and personnel resources to ensure efficient operation of the plan. For example, sufficient staff should be assigned to the environmental health officer to ensure the efficient operation of the waste management plan.

Ensure that monitoring procedures are incorporated into the plan. The efficiency and effectiveness of the treatment and disposal system should be monitored so that the system can be updated and improved when necessary. Any changes should eventually be incorporated into a revised management plan.

Appoint a successor in the event of personnel leaving key positions in the waste-management team (or temporarily assign responsibility to another staff member until a successor can be appointed).

- **Ensure adequate training for staff members, and designate the staff responsible for coordinating and implementing training courses.**

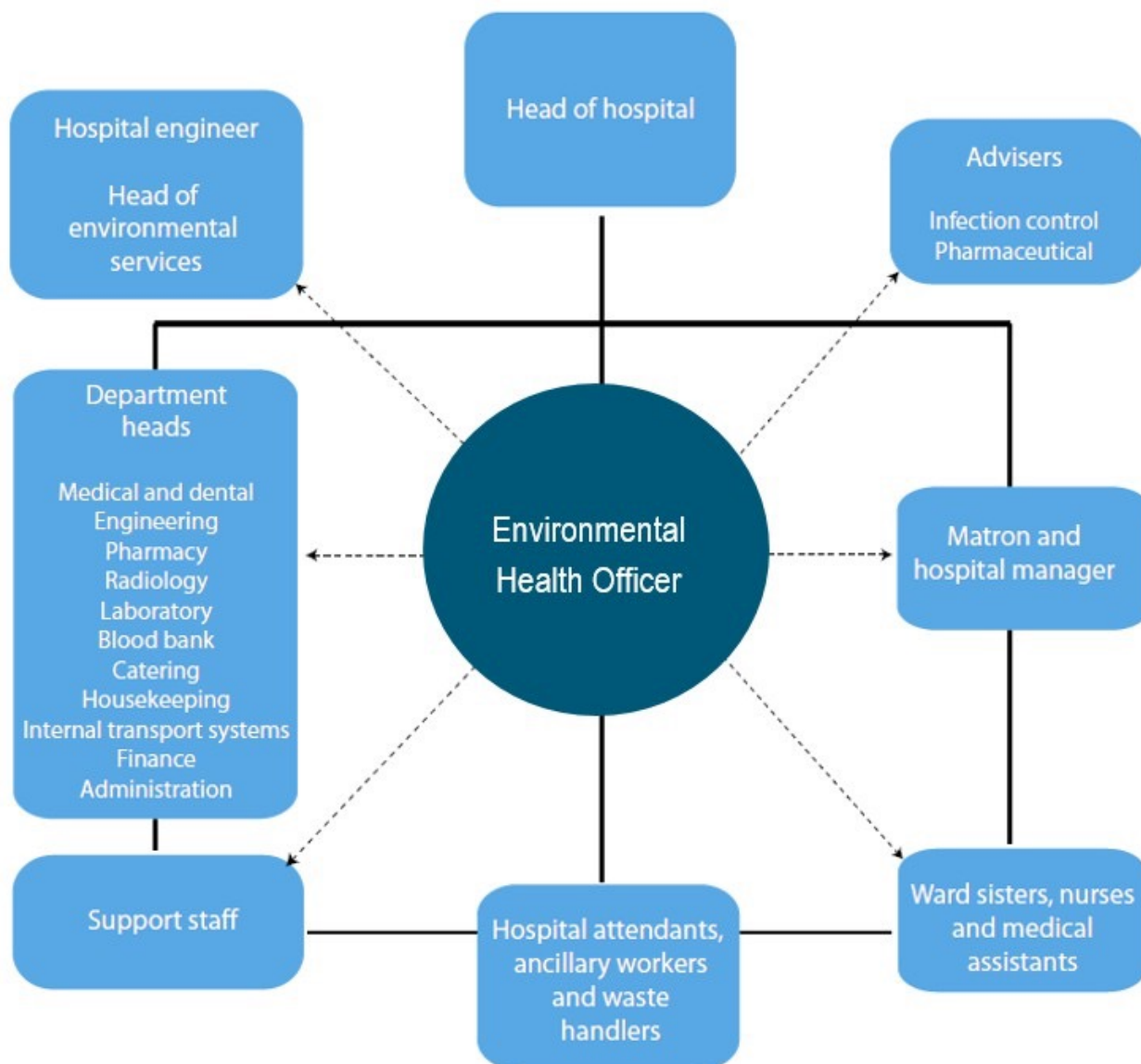

Figure 4.1: Typical example of HCWM structure in a hospital (WHO, 2014)

## ii. Environmental health officer

The environmental health officer is responsible for the day-to-day operation and monitoring of the waste-management system and is usually established as a separate post at larger HCFs. It is therefore important that the environmental health officer have direct access to all members of the hospital or the health center staff (see Figure 4.2). The role should be held by a senior environmental health officer among the staff and should

be responsible to the head of HCF. The environmental health officer should liaise with the IPC officer (if separately available), the chief pharmacist, and the radiation officer (in hospitals) so that they become familiar with the correct procedures for handling and disposing of pathological, pharmaceutical, chemical, and radioactive wastes.

To manage the waste collection, storage, and disposal, the environmental health officer should:

- control the internal collection of waste containers and their transport to the central waste- storage facility of the HCF daily;
- liaise with the supplies department to ensure that an appropriate range of bags and containers for health-care waste, Personal Protection Equipment (PPE), and collection trolleys are available at all times;
- ensure that HCF attendants and ancillary staff immediately replace used bags and containers with the correct new bags or containers;
- directly supervise HCF attendants, ancillary workers, and waste handlers assigned to collect and transport health-care waste;
- ensure the correct use of the central storage facility for health-care waste, which should be kept locked but should always be accessible to authorized HCF staff;
- prevent all unsupervised dumping of waste on the HCF grounds;
- coordinate and monitor all waste-disposal operations;
- monitor methods of transportation of wastes both onsite and offsite and ensure that wastes collected from the HCF are transported by an appropriate vehicle to the designated treatment and disposal site if managed outside;
- ensure that waste is not stored for longer than specified in the guidelines and that the transport organization (which may be the local authority or a private contractor) collects the waste with the required frequency.

To organize staff training and information, the environmental health officer should be responsible for the following actions:

- Liaise with the matron (or senior nursing officer) and the HCF manager to ensure that the medical staff and medical assistants are aware of their responsibilities for the segregation and storage of waste, as well as for the correct closing and sealing of bags and containers.
- The environmental health officer also defines the duties of HCF attendants and ancillary staff on the handling and transport of sealed waste bags and containers.
- Liaise with department heads to ensure that all doctors and clinical staff are aware of their responsibilities regarding waste segregation, and storage and closing and sealing of waste bags, to minimize infection risks, as well as the responsibilities of HCF attendants and ancillary staff regarding the handling and transport of sealed bags and containers.
- Ensure that waste handlers are properly trained in waste collection and treatment, as well as safe and sufficient disposal methods, including how to operate and maintain machines and technology. Refresher courses should be provided on a routine basis.
- Ensure compliance with occupational health measures, including current practices for post- exposure prophylaxis, as well as the provision and use of personal protective equipment.

**To prepare for incident management and control, the environmental health officer should:**

- *Ensure that written and pictorial emergency and contingency procedures are available, that they are in place at all times, and that personnel are aware of the action to be taken in the event of an emergency,*
- *Investigate and review any reported incidents concerning the handling of health-care waste (in liaison with the IPC department).*

Also, the environmental health officer should continuously monitor certain parameters, as in the example listed below.

**A. Waste generated each month, by waste category:**

- in each department's treatment and disposal methods.

**B. Waste handled safely and per the safety operation procedures:**

- occupational safety (e.g. personal protective equipment)
- use of proper and clean equipment and marking equipment
- proper segregation at source
- internal safe transport and storage
- internal safe treatment methods
- safe disposal methods if on premises of the health-care facility.

**C. Financial aspects of health-care waste management:**

- direct costs of supplies and materials used for collection, transport, storage,

treatment, disposal, decontamination, and cleaning

- training costs (labor and material)
- costs of operation and maintenance of onsite treatment facilities
- costs for contractor services.

**D. Public health aspects:**

- Incidents resulting in injury, "near misses" or failures in the handling, segregation, storage, transport, or disposal system should be reported to the infection-control officer and the environmental health officer. This information should be used to decide the preventive measures to avoid recurrences.

**iii. Department heads**

Department heads are responsible for the segregation, storage, and disposal of waste generated in their departments. They should:

- ensure that all doctors, nurses, and clinical and non-clinical professional staff in their departments are aware of the segregation, sealing, and storage procedures and that all personnel comply with the highest standards;
- liaise regularly with the environmental health officer to monitor working practices for failures or mistakes;
- ensure that key staff members in their departments are trained in waste segregation and disposal procedures;
- encourage medical and nursing staff to be vigilant to ensure that HCF attendants and ancillary staff follow correct procedures at all times.

#### **iv. Matron and HCF administrator/manager**

The matron (or senior nursing officer) and the HCF manager are responsible for training nursing staff, medical assistants, HCF attendants, and ancillary staff in the correct procedures for segregation, sealing, storage, transport, and disposal of waste. They should:

- liaise with the environmental health officer and the advisers (IPC officer, chief pharmacist, and radiation officer) to maintain high standards of infection control;
- participate in staff induction and refresher training in the handling and treatment and disposal of health-care waste;
- liaise with department heads to ensure coordination of training activities and decide what to do about waste management issues specific to particular departments.

#### **v. Infection prevention and control officer (in any)**

The IPC officer should liaise with the environmental health officer continually, and provide advice about the control of infection, and the standards of the waste treatment and disposal system. The IPC officer's duties that relate to health-care waste include:

- identifying training requirements according to staff grade and occupation
- organizing and supervising staff training courses on the infection risks from poor waste management
- liaising with the department heads, the matron, and the HCF manager to coordinate training. The IPC officer may also have overall responsibility for chemical disinfection, the safe management of chemical stores and minimizing chemical waste creation.

#### **vi. Chief pharmacist**

The chief pharmacist is responsible for the safe management of pharmaceutical stores and for minimizing pharmaceutical waste. Duties include:

- liaising with department heads, the environmental health officer, the matron, and the HCF manager, and giving advice, following the national policy and guidelines, on the appropriate procedures for pharmaceutical waste treatment and disposal;
- coordinating continual monitoring of procedures for the treatment and disposal of pharmaceutical waste;
- ensuring that personnel involved in pharmaceutical waste handling, treatment, and disposal receive adequate training;
- enduring up to date with the proper treatment and safe disposal of expired, damaged, and unusable pharmaceuticals, pharmaceutical packaging, and equipment.

The chief pharmacist also has the special responsibility of ensuring that genotoxic products are used safely, and that genotoxic waste is managed safely.

#### **vii. Radiation officer**

The duties and responsibilities of the radiation officer are the same as those of the pharmaceutical officer but relate to radioactive waste. There may also be additional regulations regarding the storage and safeguarding of radioactive wastes. These regulations need to be followed strictly for the safety of those handling the wastes.



### viii. General service/Supply officer

The supply officer should liaise with the environmental health officer to ensure a continuous supply of the items required for waste management (plastic bags and containers of the right quality, spare parts for onsite health-care waste-treatment equipment). These items should be ordered in good time to ensure that they are always available, but the accumulation of excessive store supplies should be avoided. The supply officer should also investigate the possibility of purchasing environmentally friendly products (e.g. polyvinyl chloride-free plastic items).

## 4.4 Implementation of HCWM

In general, implementation of the HCWM plan mainly at HCF level includes the following systematic activities as a starting point and progress as planned.

**Step 1:** Interim measures, to be introduced as a precursor to complete implementation of the new waste-management system, should be developed by the environmental health officer, in collaboration with the waste-management committee, and be appended to the plan. A chart should also be added, showing dates of implementation of each part of the new system.

**Step 2:** Provision for future expansion of the HCF or waste-storage facilities should be made.

**Step 3:** The head of the HCF appoints personnel to the posts with responsibility for waste management. Notices of these appointments should be widely circulated, and updates should be issued when changes occur.

**Step 4:** The IPC officer should organize and supervise training programs for all staff, in collaboration with the environmental health officer and other members of the waste-management committee.

Once the above steps have been completed and the necessary equipment for waste management is available, the operations described in the waste-management plan can be put into practice. The waste-management committee should review the waste-management plan annually and initiate changes necessary to upgrade the system.

The head of HCF should prepare an annual report to the higher body (Federal, regional, or zonal health office) responsible for the disposal of health-care wastes, providing data on waste generation and disposal, personnel and equipment requirements, and costs.

## 4.5 Monitoring and evaluation

Regular monitoring and evaluation of the plan in each HCF should be performed. It helps to find out the loopholes, bottlenecks and reveal the new issues, which have come in managing the HCWs. It helps to have recommendations and shortcomings of the programs and provides an opportunity to educate staff and reinforce good practices. Three types of monitoring mechanisms need to be enforced for the progressive improvement and sustainability of the HCWM system. They are:

- Baseline monitoring
- Compliance monitoring
- Impact monitoring

Baseline and compliance monitoring should be performed by the person(s)/authority designated by the existing HCWM committee. Impact monitoring and evaluation should be conducted through a third party i.e. externally. A comprehensive list of indicators for compliance and impact monitoring must be developed for the effective implementation of the HCWM plan.

Baseline monitoring identifies the changes in basic environmental conditions whereas compliance monitoring identifies whether the concerned parties follow the rules and guidelines or not. Compliance monitoring should be done at two stages, one during the construction of the treatment unit/facility and another during the operation of the entire plan. At the construction phase, it is important to check out whether the appropriate equipment is being installed properly. During operation, it has to be ensured that infectious, hazardous wastes are being handled properly, and the equipment is being operated as per the SOP. The monitoring should comply with Environmental Impact Assessment (EIA) and Initial Environmental Examination (IEE) requirements along with the HCF requirements.

Impact monitoring pinpoints the positive and negative changes that have been brought about by the establishment of the HCWM system. Impact evaluation should thoroughly analyze:

- Impact
- Relevance
- Effectiveness and efficiency
- Sustainability
- Replicability

During impact evaluation, the recommendation and major lesson learned should also be provided through an opinion survey, consultation, and secondary data analysis.

# 5 Health-care waste management principles

The proper management of health-care waste depends on good organization, sufficient funding, and the active participation of informed and trained personnel. Those are the preconditions for the consistent application of measures throughout the waste chain (from where it is generated to where it is eventually disposed of).

Very often, waste management is relegated to the rank of an unskilled task, whereas it ought to be valued and all actors in a health-care facility made to realize their share of responsibility. However, it is poorly understood why HCW should receive special management methods different from those used for other categories of wastes such as residential waste or municipal waste, and, particularly, why HCW should be segregated at its point of generation. Furthermore, the constraints related to its management as well as the funds required to set up a proper management system discourage many medical institutions from undertaking the necessary steps to improve their current HCWM practices. It often is considered a less important task consuming extended budget and resources.

On the contrary, HCWM is an integral part of hygiene and infection and control within an HCF, which its proper management not only controls nosocomial infections but also improves health-care service provided and improves the working standard of HCF's personnel. It is also mandatory for an HCF and employees to comply with federal and local regulations of HCWM to minimize the overall risks to HCWs and the public.

Hazardous Waste Management and Disposal Control Proclamation No.1090/2018 of Ethiopia indicated that individual and institutions involved in such activities must minimize the release of hazardous waste by reducing or eliminating the hazardous substances in the raw materials and during production and create conditions necessary for the collection and reusability or recyclability of the product. Besides waste generators must properly segregate, collect, store, transport, treat and dispose of according to the guidelines provided by international and national organizations to protect public health and the environment.

In this context, the following basic steps, considered as a 'waste management hierarchy' are considered essential for proper waste management. Figure 5.1 below shows a summary of the efficient HCWM step, which is discussed in detail later in this section.

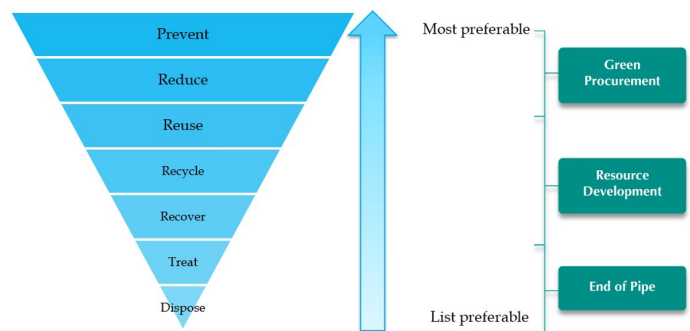

Figure 5. 1: The waste management hierarchy

The HCW generated within the HCF follows an appropriate and well-identified stream from point of generation until their final disposal, which is composed of several steps that include waste generation, segregation,

collection, transportation (on-site and off-site), storage, treatment, and disposal. To illustrate, Figure 5.2 summarizes the HCW handling – the flow of waste from point of generation up to its final disposition.

Step	Location	HCWM process	Key points
0	Procurement		Green procurement policy, stock management, Life Cycle Analysis (LCA), resource development (3R's)
1	At source/point of generation (HCFs)	Generation	Color-coded bins, proper segregation
2		Segregation at source	The most important step to reduce risks and generation of HCW
3		Onsite collection and transport	PPE, color-coded dedicated storage bins, easy to use, with dedicated trolleys
4		Onsite storage	Central HCW storage, lockable, easy to clean, compliant with standards
5		Onsite treatment and disposal	Adequate space, available of acceptable treatment and disposal method within the HCF
6	Outside the HCF	Offsite transport	Approved and up to the standard transportation, proper labeling, clear feedback for the HCF team
7		Offsite treatment and disposal	Up to the standard treatment (e.g. incinerator) and disposal (e.g. sanitary landfill), proper monitoring and control

Figure 5. 2: HCW handling in HCFs – the flow of waste from point of generation to its final disposal

## 5.1 Source reduction and minimization

The underlying principle of Waste Minimization is rooted in the Hierarchy of Controls, that prevention is very important, thus before producing waste; the HCF shall investigate whether the amount of waste to be generated from the daily operation of the HCF could be minimized to reduce the efforts in subsequent handling, treatment, and disposal operations. The critical point in minimizing waste starts from the planning stage of the preparation of the Annual Procurement Plan (APP), which includes the list of items required for HCF activities.

### **The management of HCF must adopt the following strategies to implement waste minimization:**

- Establish an updated database for the waste generation rates, current hazardous waste management strategies, and current waste management costs;
- Institutionalize waste minimization and sustain the program in the long run;
- Have a written policy with established vision and mission to implement Waste Minimization Program;
- Be aware of their specific role in HCWM and be properly trained in waste minimization; and
- Adopt the Green Procurement Policy (GPP)

### 5.1.1 Avoiding or prevention

The most preferable approach, if locally achievable, is to avoid producing waste as far as possible. It seems unrealistic for HCF to operate without producing waste. However, it is always wise to look for possibilities if any specific health-care service provided can be implemented without producing waste at all. Avoiding unnecessary procedures, which may be managed by other methods without consuming resources, is an example of avoiding waste from production.

### 5.1.2 Minimization at source

Waste minimization can be done in two points of the HCW handling. Best practice waste management will aim to avoid or recover as much of the waste as possible in or around an HCF, rather than disposing of it by burning or burial. This is sometimes described as tackling waste “at source” rather than adopting “end-of-pipe” solutions.

Waste can be minimized during the procurement of materials needed by the HCF (Step 0 of Figure 5.2). By purchasing environmentally friendly products, one can already minimize the amount of waste to be generated. To achieve lasting waste reduction (or minimization), the focus should be on working with HCF staff to change clinical practices to ones that use fewer materials. Although waste minimization is most commonly applied at the point of its generation, health-care managers can also take measures to reduce the production of waste through adapting their purchasing and stock control strategies. Suppliers of chemicals and pharmaceuticals can also become responsible partners in waste minimization programs. The HCF can encourage this by ordering only from suppliers who provide

rapid delivery of small orders, who accept the return of the unopened stock, and who offer off-site waste management facilities for hazardous wastes.

Waste can also be minimized through segregation. In this process, the 3R's (reduce, reuse and recycle) principle is applied, effectively reducing the amount of waste to be treated or collected. Waste minimization at the national or HCF level can be achieved by instituting several measures including the techniques discussed in the section below.

### 5.1.3 Safe and environmentally friendly purchasing

Waste can be minimized in an HCF through proper procurement planning. Environmentally friendly/preferable purchasing refers to the purchase of the least damaging products and services, in terms of environmental impact. It is as simple as the purchase of recycled paper, through to more sophisticated measures such as the selection of medical equipment based on an assessment of the environmental impact of the equipment from manufacture to final disposal which is the approach of "life-cycle thinking". Addressing the issue of HCW at the source is more economically and environmentally beneficial than looking into the perennial issue of waste management disposal.

Choosing products during purchasing by their safety and environmental friendliness can help health-care centers to reduce their overall impact on the environment, provide healthier conditions for patients and staff by switching to less hazardous materials (e.g. solvents, cleaning fluids), and lower the costs related subsequently to waste disposal. A widely cited example is the purchase of

mercury versus a mercury-free thermometer. When mercury thermometers break, there are costs associated with cleaning up a hazardous material and then preventing mercury from entering the environment at the final disposal stage.

#### Some of the factors to be considered in environmentally friendly or green procurement are as follows:

- Less toxic
- Minimally polluting
- Energy efficient
- Safer and healthier for patients, workers, and the environment
- Higher recyclability and recycled content

### 5.1.4 Safe reuse

Another option for waste minimization is safe re-use. Re-use is not only finding another use for a product but also, more importantly, reusing the product repeatedly for a given function as intended. Promoting re-use entails the selection of reusable rather than disposable products whenever possible. Re-use will also involve setting reliable standards for disinfection and sterilization of equipment and materials to ensure safety (see Table 5.1). Reuse requires a realistic assessment of which reuse practices are considered safe and which to avoid because the risk of infection transmission to patients and staff is unacceptable.

When considering reuse, it is important to make a distinction between different types of products:

- Non-medical supplies, disposable items (which should be avoided);
- Medical devices that pose no cross-infection risk (e.g., blood pressure meters); and
- Medical devices specifically designed for reuse (e.g., surgical instruments).

Before the reuse of the product, it must undergo the steps of **(1) cleaning; (2) decontamination; (3) reconditioning; (4) disinfection; and (5) sterilization.**

The following are the products that can be reused:

- Certain devices that are intended for limited reuse by the individual and only require washing with mild detergents (e.g., patient self-administered intermittent urinary catheters, face masks for oxygen administration);
- Long-term radionuclides conditioned as pins, needles, or seeds and used for radiotherapy may be reused after sterilization;
- Special measures must be applied in case of potential or proven contamination with the causative agents of transmissible spongiform encephalopathies;
- Certain types of containers, provided they are carefully washed and disinfected;

Pressurized gas containers should be sent to specialized centers to be refilled and used. Items that cannot be reused are the following:

- Single-use devices or items, such as syringes and hypodermic needles, must not be reused because of the risk of cross-infection. Where syringes are in short supply, nurses may replace the needle, but the chance of infection remains. A

syringe that has been rinsed but not sterilized can still have a 1.8% chance of passing on human immunodeficiency virus if used for intravenous injection and 0.8% for intramuscular injection

- Plastic syringes and catheters should not be reused. However, they may be recycled after sterilization.
- Disposable items such as gloves, masks and gowns should not be reused.

For safe reuse of reusable materials, the following are examples of sterilization methods that offer the proposed result:

### Thermal sterilization

- **Dry sterilization:** Exposure to 160°C for 120 minutes or 170°C for 60 minutes in a “Poupinel” oven.
- **Wet sterilization:** Exposure to saturated steam at 121°C for 30 minutes in an autoclave.

### Chemical sterilization

- **Hydrogen peroxide:** A 7.5% solution can produce high-level disinfection in 30 minutes at 20°C. Alternatively, equipment exists that can generate a hydrogen peroxide plasma from a 58% hydrogen peroxide solution within 45-minutes of the equipment’s process time. Hydrogen peroxide can also be used in combination with peracetic acid.
- **Peracetic acid:** Can produce sterilization in 12 minutes at 50–55°C, with instruments ready to use in 30 minutes. Peracetic acid can also be used in combination with hydrogen peroxide.
- **OPA (ortho-phthaldehyde):** High-level disinfection in 12 minutes at 20°C.
- **Hypochlorous acid/hypochlorite:** 400–450 ppm active free chlorine, contact conditions established by simulated use testing with endoscopes.

## 5.1.5 Recycling and recovery

Recycling involves the processing of used materials (waste) into new products to prevent loss of potentially useful materials, reduce the consumption of fresh raw materials, reduce energy usage, reduce air pollution and water pollution (from landfilling) by reducing the need for “conventional” waste disposal and lower greenhouse gas emissions as compared to virgin production. However, from an environmental perspective, recycling

is less desirable than reusing a waste item, because it frequently requires substantial energy input and transport to off-site recycling centers.

Recyclable materials include many kinds of glass, paper, metal, plastics (see Figure 5.3), textiles, and electronics. Materials to be recycled are brought to a collection center or picked up from the curbside, then sorted, cleaned, and reprocessed into new materials bound for manufacturing.







1 PETE	2 HDPE	3 PVC	4 LDPE	5 PP	6 PS	7 OTHER
Polyethylene Terephthalate	High-Density Polyethylene	Polyvinyl Chloride	Low-Density Polyethylene	Polypropylene	Polystyrene	Other
Common products: soda & water bottles; cups, jars, trays, clamshells	Common products: milk jugs, detergent & shampoo bottles, flower pots, grocery bags	Common products: cleaning supply jugs, pool liners, twine, sheeting, automotive product bottles, sheeting	Common products: bread bags, paper towels & tissue overwrap, squeeze bottles, trash bags, six-pack rings	Common products: yogurt tubs, cups, juice bottles, straws, hangers, sand & shipping bags	Common products: to-go containers & flatware, hot cups, razors, CD cases, shipping cushion, cartons, trays	Common types & products: polycarbonate, nylon, ABS, acrylic, PLA; bottles, safety glasses, CDs, headlight lenses
Recycled products: clothing, carpet, clamshells, soda & water bottles	Recycled products: detergent bottles, flower pots, crates, pipe, decking	Recycled products: pipe, wall siding, binders, carpet backing, flooring	Recycled products: trash bags, plastic lumber, furniture, shipping envelopes, compost bins	Recycled products: paint cans, speed bumps, auto parts, food containers, hangers, plant pots, razor handles	Recycled products: picture frames, crown molding, rulers, flower pots, hangers, toys, tape dispensers	Recycled products: electronic housings, auto parts,
						

Figure 5.3: Recyclable plastics identification codes (ASTM, 2020)

Recycling is increasingly popular in some HCFs, especially for the large, non-hazardous portion of waste. It can reduce costs considerably, either through reduced disposal costs or through payments made by a recycling company for the recovered materials.

Some of the hazardous infectious portions of the waste will contain recyclable materials (e.g., paper, cardboard, packaging, and tubing). These materials can also be recycled, provided they are disinfected to eliminate possible pathogens, and safe handling guidelines are followed.



The recovery of waste is defined in two ways. Most simply, recovery refers to energy recovery, whereby waste is converted to fuel for generating electricity or for direct heating of premises. Alternatively, waste recovery is a term used to encompass three sub-sets of waste recovery: recycling, composting, and energy recovery.

Composting hospital food waste is attracting interest, particularly in countries where the use of landfills is becoming more restrictive due to legislation, taxation, service charges, or land shortages.

There are legitimate concerns about compost attracting rodents and other pests; however, these problems can be minimized with careful management.

In determining the economic viability of recycling and recovery, it is important to take account of the costs of alternative disposal methods, as well as the value of reclaimed materials, and not just the cost of the recycling and recovery process.

## 5.2 Segregation, storage, collection and transportation

Proper segregation of HCW at the point of generation and collection, storage, and transport for treatment before its final disposal is the crucial stage in HCWM. Segregation is the key to effective waste management and the only implementation of proper waste management can ensure all HCW will be treated according to the hazards. HCF managers have a “duty of care” to ensure that waste is kept under control at all times within the HCF and disposed of safely either on-site or off-site.

### The following general principles relate to the control of waste flow from generation to disposal:

- HCWs generated in an HCF should be segregated into different fractions based on their potential hazard and disposal route, by the person who produced each waste item.
- HCW must be segregated, collected, stored, and transported in a safe manner considering the risk and occupational hazard, and per existing laws, policies, and guidelines.
- Hazardous and general waste must not be mixed during collection, transport, and storage.
- Separate containers should be available in each medical area for each segregated waste fraction.
- Appropriate labeling, signage, route, and segregation system must be established. Waste containers when filled should be labeled to help managers control waste production.
- Plastic liners preferably containing three-quarters full of waste must be sealed when transported from the waste generating source to the storage area.
- The storage area must be designed based on the volume of waste generated by the HCF and must be provided with compartments for general, hazardous, and recyclable wastes. Closed local storage inside or near a medical area may be needed if wastes are not collected frequently.
- Staff must be well trained on the risk and safety procedures on handling waste.

## 5.2.1 Segregation

Segregation is an important element for efficient health-care waste management. By separating hazardous from non-hazardous waste, one can dramatically reduce the volume of waste that requires specialized treatment. Other elements of health-care waste management, at this stage, include packaging (containerization), color-coding, labeling, signage, handling, transport and storage.

Segregation is the process of separating different types of waste at the point of generation until its final disposal. The correct segregation of HCW is the responsibility of *the person who produces each waste item, whatever their position in the organization.*

Segregation at the point of generation reduces the health risk from the smaller potentially infectious fractions (typically waste items contaminated with body fluids and used sharps). With proper segregation, appropriate resource recovery and recycling

techniques can be applied to each separate waste stream. Proper segregation may also minimize the quantity of hazardous wastes that need to be treated thus, prolonging the operational life of the disposal facility and may gain benefit in terms of conservation of resources. To improve segregation efficiency and minimize incorrect use of bins, proper placement, labeling of waste bins and use of color-coded plastic liner must be strictly implemented.

### Color coding and labeling waste containers

The purpose of color-coding is to make it easier for HCF workers to put the waste into correct bins and maintain segregation during collection, storage, transport, treatment, and disposal. The color - coding scheme of waste bin/container per type of HCW is likewise indicated in Table 5.1. HCFs may adopt the color-coded waste bin or innovate using recycled materials.

**Table 5. 1: WHO-recommended segregation scheme with container type and color-coding**

Type of waste	Color of container and markings	Type of container
Highly infectious waste	Yellow, marked "HIGHLY INFECTIOUS", with biohazard symbol	Strong, leak-proof plastic bag, or container capable of being autoclaved
Other infectious waste, pathological and anatomical waste	Yellow with biohazard symbol	Leak-proof plastic bag or container
Sharps	Yellow, marked "SHARPS", with biohazard symbol	Puncture-proof container
Chemical and pharmaceutical waste	Brown, labeled with appropriate hazard symbol	Plastic bag or rigid container

The waste bins must also be labeled according to the type of waste to avoid confusion in the disposal of the wastes. The label must contain symbols representing the hazard classifications of the wastes or any necessary hazard labels, internationally recommended symbols recommended (preferable WHO accepted). Several symbols are relevant to the different kinds of hazardous waste produced in a healthcare facility; few examples are indicated in figure 5.4 while the rest of the symbols can be found in Annex-2. A simple approach in labeling is to attach a tag to each filled container.

**The label should contain at least the following information on it:**

- Name of the HCF;
- Area of the HCF where the waste was generated (or the source);
- Type of waste and the weight and date of collection on-site, or date and time of closure of the container; and
- Name of the person filling out the label.



Biohazard symbol



New radiation symbol



Old radiation symbol (which is still in use)

**Figure 5. 4: Biohazard and radiation hazard (new and old) symbols**

**Sharps**

Sharps waste is a subset of infectious waste and comprises syringes, needles, lancets, broken glass and any other materials that can pierce the skin. The combination of contamination with pathogens and the ability to break through the skin’s protection makes them one of the most dangerous wastes produced in healthcare. Aside from posing a risk to patients and healthcare workers from hazardous or infectious materials, they can pierce or lacerate the skin producing injury and making infection more likely. Never put sharps in general waste bins or garbage

cans. It is always advised to use especially dedicated containers and, it should not be filled more than three-quarters of the box. All sharps should be collected together, regardless of whether they are contaminated or not. The container should be puncture-proof made of either cardboard, metal or high-density plastic and fitted with covers (Figure 5.5). It should be rigid and impermeable to contain not only sharps but also any residual liquids from syringes. To discourage abuse, containers should be tamper-proof and needles and syringes should be rendered unusable.



**Figure 5.5: Safety boxes (sharp containers)**

### Specification and siting HCW containers

Waste bins are of different types. Some bins are designed for automated systems others are re-used plastic and metal containers. The general specifications of the waste bins and plastic liners that must be followed are as follows:

- The most important is the quality of material – it shall be sturdy and leak-proof;
- Bins shall have well-fitting lids, either removable by hand or operated by a foot pedal;
- Both bins and plastic liners shall be, preferably, of the same color for the type of waste to be placed. This is to avoid confusion and poor segregation;
- The recommended thickness of the plastic liners is 0.07mm (ISO 7765 2004). Plastics used for either containers or bags should be chlorine-free. Not all plastic bags can withstand temperatures of 121°C, and some can melt during an autoclave process;
- Containers should be large enough for the quantity of waste generated at a specified location during the period between collections; and

- Containers should be of similar size to overcome the observed tendency for staff to put waste in the largest receptacle.

The appropriate waste receptacle (bags, bins, sharps boxes) should be available to staff in each medical and other waste-producing area in the HCF. This permits staff to segregate and dispose of waste at the point of generation and reduces the need for staff to carry waste through a medical area.

Segregation should be carried out by the producer of the waste as close as possible to its place of generation, which means segregation should take place in a medical area, at a bedside, in an operating theatre or laboratory by nurses, physicians and technicians. The following must be considered in selecting the location of waste bins in the HCF:

- Hazardous waste containers should be located away from patients; typical sites are the sluice (utility) room, treatment room and nurses' station.
- Where containers for segregating hazardous and non-hazardous HCWs are in use, they should be located close together, wherever possible.
- Containers for hazardous waste like infectious waste should not be placed in public areas because patients and visitors may use the containers and be exposed to potentially infectious waste items.

Only waste bins for general non-hazardous waste bins must be in public areas.

- Waste bins with yellow liners for infectious wastes shall be placed in, but not limited to, the following areas away from the public: emergency room, outpatient department, laboratory, radiology, dental and isolation rooms, infectious

wards, and dialysis and nurses stations. The alternative is establishing a limited number of locations in a medical area where general waste (black bags) and infectious HCW (yellow bags and sharps containers) are placed.

- Static bins should be located as close as possible to sinks and washing facilities because this is where most staff will deposit gloves and aprons after treating patients. If the general waste container is closest to the sink or under a towel dispenser, it will encourage staff to place towels into the non-infectious receptacle.
- Unless patients are known or suspected to have readily transmitted infections, the assumption should be that general waste generated in a medical area is of low risk. However, if there is a known communicable infection (e.g., COVID 19, methicillin-resistant staphylococcus aureus, tuberculosis, or leprosy), all waste used in and around the patient should be classed as infection risk and placed in the yellow, potentially infectious waste container.

If intervention at the bedside is required, a waste container should be taken to the bed –

- preferably placed on or at a trolley or cart. Sharps bins are also sometimes taken to a patient for drug administration or blood sampling. A mobile trolley with infectious waste and
- sharps containers may therefore be more versatile and should be given serious consideration, especially in higher hospitals.

### 5.2.2 HCW Collection

Proper collection and transport of HCW is an important component in HCWM. Its

implementation requires commitment and cooperation of the HCF's maintenance, housekeeping, and motor pool services personnel and all the HCF workers. HCW collection and transport practices shall be designed to achieve an efficient movement of waste from point of generation to storage or treatment while minimizing the risk to the personnel.

This refers to the collection of wastes from the waste bins going to the on-site storage area of the HCF by the general service personnel. Collection times should be fixed and appropriate to the quantity of waste produced in each area of the HCF. The following are the general guidelines for the on-site collection of the HCW.

Follow the established plan for the collection and transport of HCW.

- Infectious and general waste should be collected daily (or as frequently as required) with collection time matching the pattern of waste generation during the day. For example, in a medical area where the morning routine begins with the changing of dressings, infectious waste could be collected mid-morning to prevent soiled bandages remaining in the medical area for longer than necessary. Visitors arriving later in the day will bring with them an increase in general waste, such as newspapers and food wrappings; therefore, the optimum time for general and recyclable waste collection would be after visitors have departed.
- Waste bags should be filled to no more than three-quarters of the container. Once this level is reached, they should be sealed ready for collection. Plastic bags should never be stapled but may be tied or sealed with a plastic tie.

Sharp containers should be collected when three-quarters full.

Pharmaceutical and chemical waste can be collected on demand.

Radioactive waste should be collected after the finalization of the procedure.

- Upon waste collection, the person must ensure that the waste bags and containers are properly labeled as discussed in section 5.2.1 above.
- Replacement bags or containers should be available at each waste collection location so that full ones can immediately be replaced.

### 5.2.3 On-site Transport of HCW

This refers to the transport of the wastes from the point of generation to the on-site waste storage area.

#### **In doing the on-site transport, the following must be observed:**

- Transport of the collected HCW must be done using wheeled trolleys/carts or wheeled bins;
- On-site transport should take place during less busy times whenever possible. Set routes should be used to prevent exposure to staff and patients and to minimize the passage of loaded carts through patient care and other clean areas;
- Depending on the design of the HCF, the internal transport of waste should use separate floors, stairways, or elevators as far as possible. On-site transport of HCW in HCFs with more than two-story building/s shall use service

elevators, mechanical pulley, hoist, or ramp. In the case of elevators or ramps, the schedule of on-site transport of HCW shall be before the end of shift of workers, preferably not coinciding with scheduled visiting hours;

- Regular transport routes and collection times should be fixed and reliable;
- Transport staff should wear adequate personal protective equipment, gloves, strong and closed shoes, overalls, and masks;
- Hazardous and non-hazardous waste should always be transported separately. The use of waste chutes in HCFs is not recommended, because they can increase the risk of transmitting airborne infections;
- Hazardous waste should never be transported by hand due to the risk of accident or injury from infectious material or incorrectly disposed sharps that may protrude from a container;
- General wastes should not be collected and transported at the same time as the infectious or other hazardous wastes; trolley or cart

There should be a dedicated transport trolley or cart for each waste category. There should be at least a cart dedicated to infectious waste, non-biodegradable and biodegradable/recyclable. The transport trolleys or carts should be colored based on the appropriate colored code and properly labeled.

- Waste transportation carts for general waste should be painted black, only be used for non-hazardous waste types, and labeled clearly “General waste” or “Non-hazardous waste”.
- For infectious wastes, the transportation carts should be painted yellow and clearly labeled with an “infectious waste” sign.

The transport wheeled trolley or cart can be single or can accommodate up to three collection bins. To avoid injuries and infection transmission, trolleys and carts should meet the following requirements:

- a. Easy loading and unloading be easy to push and pull with heavy-duty wheel caster;
- b. Be easy to clean and, if enclosed, fitted with a drainage hole and plug;
- c. Have no sharp edges that could damage waste bags or containers during loading and unloading;
- d. Be labeled and dedicated to a particular waste type,
- e. Not be too high (to avoid restricting the view of staff transporting waste);
- f. Be secured with a lock (for hazardous waste); and
- g. Be appropriately sized according to the volumes of waste generated at the HCF.

### Onsite HCW transport routing

In general, a waste route should follow the principle “from clean to dirty”. The collection should start from the most hygienically sensitive medical areas (e.g., intensive care, dialysis, theatres) and follow a fixed route around other medical areas and interim storage locations. Upon departure from the source, no further handling shall be done.

### An efficient and effective collection system route shall consider the following:

- a. Assignment of worker responsible for the zone or area;
- b. Logical planning of the route (shall avoid passing congested areas);
- c. Schedule of the collection;
- d. All logical progression of HCW, and waste type;
- e. Waste volume and number of waste bags or containers;
- f. The capacity of the waste storage within medical areas and at interim storage area;
- g. The capacity of the transportation trolleys;
- h. Transport distances and journey times between the collection points; and
- i. An established routine plan can be revised if circumstances warrant it.

### 5.2.4 Storage at HCFs

#### Interim storage in medical departments

For hospitals, hazardous waste generated in medical areas should be stored in utility rooms, which are designated for cleaning equipment, dirty linen, and waste. From here, the waste can be kept away from patients before removal, then collected conveniently and transported to a central storage facility. This is known as interim or short-term storage.

For other HCFs that do not have available utility rooms, waste can be stored at another designated location near to a medical area but away from patients and public access. Another possibility for interim storage is a closed container stationed indoors, within or close to a medical area. A storage container used for infectious waste should be clearly labeled and preferably lockable.

### Central Storage at HCFs

Central storage areas are places within the HCF where different types of waste should be brought for safe retention until it is treated or collected for transport off-site. A storage location for HCW should be designated within the HCF. Space for storing wastes should be incorporated into a building design when new construction is undertaken. The HCF shall have a designated storage area for the following:

- i. general waste (non-hazardous or general waste)
- ii. hazardous waste
- iii. infectious and sharps waste
- iv. chemical and hazardous pharmaceutical waste
- v. radioactive waste.

If there is an area available for composting biodegradable wastes, the storage area is not necessary. It must be disposed of directly at the composting site. The HCF must use appropriate containers for storing the wastes at the central storage, which are properly labeled.

General requirements for the central storage area (except for phased-out mercury devices) are:

- Located within the HCF or research facility. However, these areas must be located away from the dietary section, patient rooms, laboratories, hospital function/operation rooms or any public access areas. It shall be protected from rain, strong winds, floods, etc.;
- Easily accessible to the staff in charge of handling the waste and for waste collection vehicle without entering HCF premises;
- Locked at all times to prevent access of unauthorized persons and entry of animals, insects, and birds;
- Floor level higher than the anticipated flood level of the area during heavy rainfall with concrete flooring that is waterproofed and adequately sloped for easy cleaning and finished with ceramic tiles;
- Impermeable, hard-standing floor with good drainage and connected to a wastewater treatment plant;
- With continuous water supply for cleaning purposes and have a washing basin with running tap water and soap that is readily available for the staff;
- With adequate ventilation, lighting, and electrical supply;
- With the supply of cleaning implements such as a water hose with spray nozzle, scrubber with a long handle, disinfectant, protective clothing, waste bags or bins and fire-fighting equipment/devices located conveniently close to the storage area;
- Have spillage containment equipment;
- Appropriate to the volumes of waste generated from each HCF; and
- With the warning sign posted in a conspicuous place outside and inside with clear symbols indicated in figure 5.6 and 5.7 below:





No entry for unauthorized persons for all storage areas



Biohazard sign for infectious and sharps waste



Toxic sign for chemical and hazardous pharmaceutical waste

*Figure 5. 6: Example labelling symbols that can be posted outside the storage facility*



*Figure 5. 7: Example labelling symbols that can be posted inside the storage facility*

### Specific hazardous waste storage requirements

In addition to the general requirements, the following specification must be considered for hazardous waste storage.

#### A. Infectious Waste Storage

- The storage place must be identified as an infectious waste area by using the biohazard sign.
- Floors and walls should be sealed or tiled to allow easy disinfection. If present, the storage room should be connected to a special sewage system for infectious HCF wastewater.
- The compacting of untreated infectious waste or waste with a high content of blood or other body fluids destined for off-site disposal (for which there is a risk of spilling) is not permitted.
- Infectious waste should be kept cool or refrigerated at a temperature preferably between 3°C to 8°C if stored for more than a week; also, sharps can be stored without problems.
- Unless a refrigerated storage room is available, storage times for infectious waste (e.g., the time gap between generation and treatment) should not exceed 48 hours during the cool season and 24 hours during the hot season.

- In situations of infectious disease pandemic like COVID 19, wastes generated from triage, quarantine, treatment or line management area should not be stored for more than 24 hours.

### B. Pathological Waste Storage

Pathological waste and the growth of pathogens it may contain are considered biologically active waste, and gas formation during storage should be expected. To minimize these possibilities, the storage places should have the same conditions as those for infectious and sharps wastes.

Body parts passed to the family for ritual procedures or buried in designated places should be placed in sealed bags to reduce infection risks before releasing to the public.

However, in special conditions like COVID 19, a body or body part of COVID 19 patient should be handled according to the guideline set by the FMOH specific to the situation.

### C. Pharmaceutical Waste Storage

In general, pharmaceutical wastes can be hazardous or non-hazardous, and liquid or solid, and each should be handled differently.

Pharmaceutical waste with non-hazardous characteristics that can be stored in a non-hazardous storage area:

- ampoules with non-hazardous content (e.g., vitamins); - fluids with non-hazardous contents, such as vitamins, salts (sodium chloride), amino salts;
- solids or semi-solids, such as tablets, capsules, granules, powders for injection, mixtures, creams, lotions, gels, and suppositories; and
- aerosol cans, including propellant-driven sprays and inhalers.

Hazardous waste that should be stored per their chemical characteristics (e.g., genotoxic drugs) or specific requirements for disposal (e.g., controlled drugs or antibiotics):

- controlled drugs (should be stored under government supervision);
- disinfectants and antiseptics;
- anti-infective drugs (e.g., antibiotics);
- genotoxic drugs (genotoxic waste) - highly toxic and should be identified and stored carefully away from other HCW in a designated secure location; and
- ampoules with, for example, antibiotics.

### D. Chemical Waste Storage

For hazardous chemical waste, the characteristics of the different chemicals to be stored and disposed of must be considered (flammable, corrosive, explosive).

- The storage place should be an enclosed area and separated from other waste storage areas.
- The storage area itself should have adequate lighting and good ventilation to prevent the accumulation of toxic fumes.
- When storing liquid chemicals, the storage should be equipped with a liquid- and chemical- proof sump. If no sump is present, catch-containers to collect leaked liquids should be placed under the storage containers.
- Spillage kits, protective equipment and first aid equipment (e.g., eye showers) should be available in the central storage area.
- To ensure the safe storage of chemical wastes, the following separate storage zones should be available to prevent dangerous chemical reactions:

- explosive waste;
  - corrosive acid waste;
  - corrosive alkali waste (bases);
  - toxic waste;
  - flammable waste;
  - oxidative waste;
  - halogenated solvents (containing chlorine, bromine, iodine, or fluorine); and
  - non-halogenated solvents.
- The storage zones should be labelled according to their hazard class. If more than one hazard class is defined for a specific waste, use the most hazardous classification.
  - Liquid and solid waste should be stored separately. If possible, the original packaging should be taken for storage too. The packaging used to store and transport chemical wastes off-site should be labelled. This label should have the following information: hazard symbol(s), waste classification, date, and point of generation (if applicable).
  - The storage area for explosive or highly flammable materials must be suitably ventilated above and below, with a bonded floor and constructed of materials suitable to withstand explosion or leakage.

#### **E. Radioactive Waste Storage**

- Liquids associated with solid materials; such as assay tube contents, should be decanted or removed by decay time.
- All radioactive labelling should be removed on any items to be disposed of.
- Empty containers of radionuclides solution are stored in a dedicated empty room, for a certain number of days, until it decays to background level.

- Storage places must be equipped with sufficient shielding material, either in the walls or as movable shielding screens. The storage must be marked with “RADIOACTIVE WASTE”, and the international hazard label should be placed on the door.
- The storage place should be constructed in a manner that renders it flameproof and should have such surfaces on floors, benches and walls that allow proper decontamination. An air- extraction system and radioactive monitoring system should be put in place.

#### **F. Mercury-containing Waste Storage**

- Even after the use of mercury has long been discontinued in the HCF, mercury-containing products may still be in storage from past uses. All HCF shall check storage areas for old, damaged, or outdated equipment. If mercury-containing products are found, contact the HCWM Officer.
- Mercury wastes shall be collected and stored in the designated storage area. It shall be clear that the mercury wastes require a more thorough storage system.
- Mercury-containing products must be stored in non-breakable containers with tight-fitting lids. The containers must be clearly labelled as to their contents.
- Rooms, where mercury-containing items are stored, shall be tested periodically using a mercury vapor sniffer or analyzer.
- After the removal of the mercury-containing products, the areas shall be checked with the mercury vapor sniffer or analyzer.
- HCF shall keep a permanent record of all materials brought in and out of the mercury storage area.

### 5.2.5 Layout of Waste Storage Areas

If new HCWM systems are developed and if new infrastructure is planned, a “waste yard” should be built. A waste yard is a place where all the relevant waste management activities are brought together. To concentrate on certain tasks, it is best to set

up multifunctional buildings (waste- storage area), including a fenced storage area for general waste, a room for infectious waste, a treatment room, a fenced area with an ash or sharps pit, a container cleaning room and a clean office with lockers and toilets. A sample layout of the waste storage area is indicated in figure 5.8.

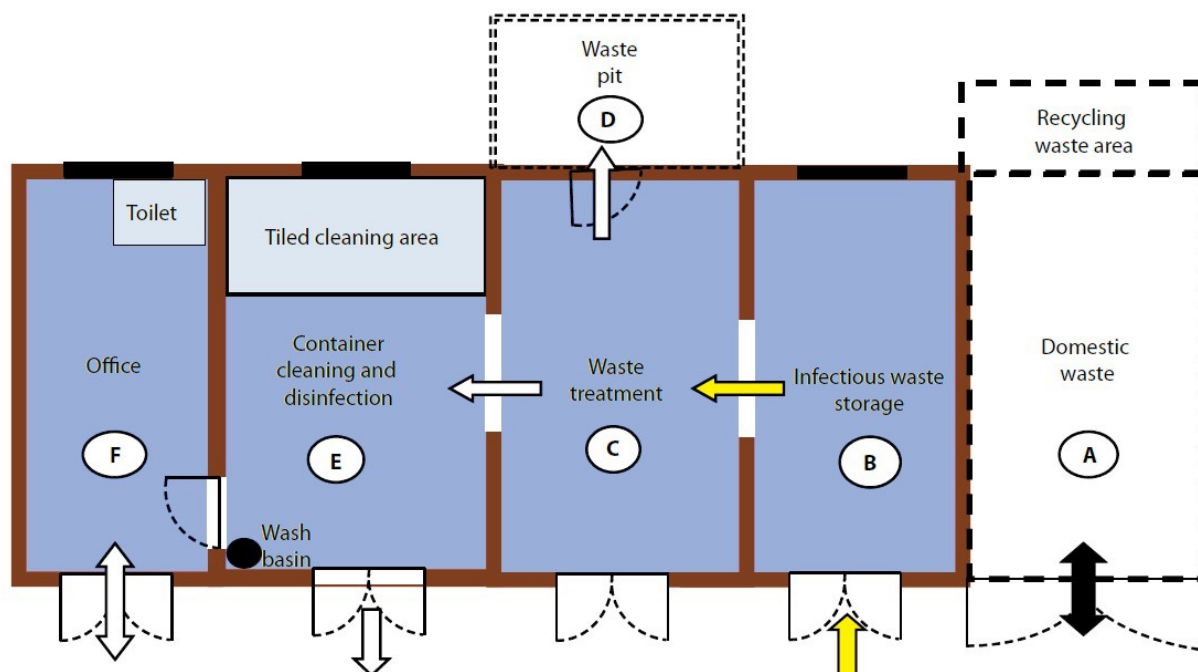

Figure 5. 8: Sample sketch of an HCF waste storage area layout (WHO, 2014)

### 5.2.6 Documentation of Operation in Waste Storage Places

For easier monitoring of the wastes that are being stored, the personnel in-charged must maintain a record of the waste stored and the dates of its storage, treatment, and disposal. Also, the following are needed to ensure the safe storage of HCW:

- a written spill contingency plan;
- a weekly store inspection protocol;
- protocols for using, repairing, and replacing emergency equipment;
- training system and documentation (names of trained staff, job descriptions, form of training, date of training, date for refresher or revalidation training);
- hazardous waste storage documentation; and
- collection of relevant material safety data sheets (MSDS).

**The following are the minimum requirements for storage of HCW:**

- Infectious, general, and used sharps waste are stored in separate color-coded containers and locations within medical areas, and subsequently at a central storage site at the HCF.
- Central storage area(s) are fenced, lockable and isolated from patients and the public.
- Maximum storage times before treatment or disposal of infectious waste is no longer than- 48 hours during the cooler season and 24 hours during the hot season.
- Staff receives instruction on three-bin waste segregation and safe handling and storage of HCW.
- Staff is aware of how to protect themselves from injuries and infection from waste.
- Waste containers and storage areas are cleaned regularly.

### 5.2.7 Off-site collection

Offsite collection is a service only implemented in the rest of the HCWM, especially the treatment and disposal, which is realized outside the HCF. This refers to the collection of waste from the HCF on-site central storage area by a designated transporter, the HCF, municipal collector or supplier into their respective vehicles. The waste collector at this point will depend on the type of waste collected.

The HCW generator is responsible for the safe packaging and adequate labelling of waste to be transported off-site for treatment and disposal. Packaging and labelling shall comply with the requirements and must not present danger to the public during transport. The off-site collector (if any) of HCW shall provide collection bins that meet the following requirements:

- Puncture-proof for sharps;
- Resistant to aggressive chemicals;
- Made of high-density polyethylene materials (HDPE);
- Must be leak-proof and be fitted with a self-sealing lid that is tight enough to withstand turbulence during transport in the vehicle; and

Infectious and pathological waste must be placed in appropriate color-coded or other special bins when transported. In the case of radioactive wastes, they must be packaged for off-site collection and transported following the accepted criteria mentioned in section 5.2.4 (E).

### 5.2.8 Off-site Transport

Offsite transport is the carriage of health-care waste on the public streets away from a health-care facility. The waste generators are ultimately responsible for ensuring that their HCW are properly treated and disposed of in an approved disposal facility.

**If off-site disposal of infectious waste is available, the following guidelines are recommended:**

- The waste should be placed in rigid, leak-proof containers before being loaded.

- Containers should be covered with lids during transportation.
- When transporting plastic bags of infectious waste, care should be taken to prevent tearing the bags.
- Vehicles used for transporting infectious waste shall be disinfected before use for any other purpose.
- The vehicles shall carry adequate supplies of plastic bags, protective clothing, cleaning tools, and disinfectants to clean and disinfect in case of any spills.
- Records must be kept documenting all transport of medical waste.

## 5.3 Treatment and disposal of HCW

### 5.3.1 Overview and selection of methods

The purpose of treatment is to reduce the potential hazard posed by HCW while endeavoring to protect the environment. Treatment should be viewed in the context of the waste management hierarchy described in Figure 5.1. The different technologies and methods in waste treatment and disposal will be discussed in detail in this section. After treatment, the wastes, which are ready for disposal, should be stored in plastic liners/containers of the same color as indicated in Table 5.1.

#### Selection of Treatment and Methods

In determining the method to be used in HCW treatment and disposal by any HCF, the HCF administrator must look

into several requirements and conditions relevant to HCWM. The choice of treatment system involves consideration of waste characteristics, technology capabilities and requirements, environmental and safety factors, and costs – many of which depend on local conditions. The treatment technology must comply with the national standards and international conventions.

Factors to consider in the selection of HCW treatment facility include:

- types and quantity of waste for treatment and disposal/capacity of the system;
- treatment efficiency;
- volume and mass reduction;
- occupational health and safety and environmental considerations;
- infrastructure and space requirements;
- locally available treatment options for final disposal;
- training requirements for operation of the method;
- cost of operation and maintenance;
- location/surroundings of the treatment site and disposal facility;
- regulatory requirements;
- social and political acceptability;
- cost of transport and disposal of treated waste; and
- cost of decommissioning.

#### **In choosing the option for treatment and disposal of HCW at primary HCFs, the following conditions must be considered:**

- The quantities of waste produced daily at the PHC level
- Availability of appropriate sites for waste treatment and disposal

- Possibility of treatment in a central facility or treatment facility within a reasonable distance.
- Rainfall and level of groundwater (e.g., to take precautions against flooding of burial pits)
- Availability of reliable transportation
- Compliance with the national policies and standards
- The availability of equipment and manufacturers in the country or region
- Social acceptance of treatment and disposal methods and sites
- Space available at the HCF
- Availability of resources (human, financial, material)
- Estimate of capital and operating cost

Low-heat thermal processes are those that use thermal energy at elevated temperatures high enough to destroy microorganisms but not sufficient to cause combustion or pyrolysis of the waste. In general, low-heat thermal technologies operate between 100°C and 180°C. The low-heat processes take place in either moist or dry heat environments.

**Pyrolysis is the thermal degradation of a substance through the application of heat in the absence of oxygen.**

- Pyrolysis is a special case of thermolysis and is most commonly used for organic materials. It occurs at high temperatures but does not involve reactions with oxygen. In practice, it is difficult to have a completely oxygen-free atmosphere, so some oxidation takes place.
- Microwave treatment is essentially a moist thermal process because disinfection occurs through the action of moist heat (hot water and steam) generated by microwave energy.
- Dry-heat processes use hot air without the addition of water or steam. In dry-heat systems, the waste is heated by conduction, convection and/or thermal radiation using infrared or resistance heaters.
- Moist (wet) thermal treatment involves the use of steam to disinfect waste, which is commonly performed in autoclave or steam-based treatment systems.

### 5.3.2 Waste treatment processes

#### A. Thermal process

Thermal treatment processes rely on heat (thermal energy) to destroy pathogens contained in the waste. This category can be further subdivided into low-heat and high-heat designs. This sub-classification is useful because of the marked differences in the thermochemical reactions and physical changes taking place in the wastes during their treatment in the different types of equipment. These differences produce very different atmospheric emissions characteristics.

## B. Chemical process

Infectious wastes can also be decontaminated by using various chemicals that kill or deactivate microorganisms. Chemical treatment processes often involve shredding, grinding, or mixing to increase the exposure of the waste to the chemical agent.

The speed and efficiency of chemical decontamination depend on operational conditions, including the type of chemical disinfectant used, its concentration, the contact time between the disinfectant and the waste, the extent of contact, the organic load of the waste, operating temperature, and factors that may affect the efficacy of the disinfectant such as humidity and pH.

### **Chemicals used should be neutralized before discharge.**

- Chemical treatment methods use disinfectants such as dissolved chlorine dioxide, bleach (sodium hypochlorite), peracetic acid, lime solution, ozone gas or dry inorganic chemicals (e.g., calcium oxide powder). However, the soaking of infectious and sharp waste in chlorine solutions has become less used due to concerns of environmental and occupational safety. Manual systems using chemical disinfection are not recommended as a reliable method for the treatment of waste.
- The Chemical system also uses heated alkali to digest tissues, pathological waste, anatomical parts, and animal carcasses in heated stainless-steel tanks.

## C. Biological process

Biological treatment processes mainly describe the decomposition or biodegradation of HCW by microorganisms that are found in the waste.

- Some biological treatment systems use enzymes to speed up the destruction of organic waste containing pathogens.
- Composting and vermiculture (digestion of organic wastes through the action of worms) are biological processes and have been used successfully to decompose hospital kitchen waste, as well as other organic digestible waste and placenta waste.
- It also includes the natural decomposition of pathological waste through burial.

## D. Mechanical process

Mechanical treatment processes include several, shredding, grinding, mixing and compaction technologies that reduce waste volume, although they cannot destroy pathogens. Mechanical processes are not stand-alone HCW-treatment processes but supplement other treatment methods.

### **Mechanical destruction can render a waste unrecognizable and can be used to destroy needles and syringes (depending on the type of shredding).**

- In the case of thermal or chemical treatment processes, mechanical



devices such as shredders and mixers can also improve the rate of heat transfer or expose more surface area of waste-to-waste treatment.

- Mechanical devices used to prepare wastes before other forms of waste destruction add significantly to the level of management and maintenance required to treat HCW safely and efficiently.

Unless shredders, mixers and other mechanical devices are an integral part of a closed treatment system, they should not be used before the incoming HCW is disinfected, otherwise, workers are at an increased risk of being exposed to pathogens in aerosols released into the environment by mechanical destruction of untreated waste bags. If mechanical processes are part of a closed system, the technology should be designed in such a way that the air in and from the mechanical process is disinfected before being released to the surroundings.

### 5.3.3 HCW Treatment Technologies

The largest proportion of the hazardous health-care waste generated is potentially infectious. The most established waste-management technologies focus on disinfection while another portion of waste is dealt with different technologies. Disinfection can be defined as the reduction or removal of disease-causing microorganisms (pathogens) to minimize the potential for disease transmission whereas sterilization is the destruction of all microbial life. Since the complete destruction of all microorganisms is difficult to establish, sterilization of

medical and surgical instruments is generally expressed as a 6 log<sub>10</sub> reduction (i.e. a 99.9999% reduction) or greater of a specified microorganism that is highly resistant to the treatment process.

## I. Steam Treatment Technology

### A. Autoclave

Autoclaves are capable of treating a range of infectious waste, including cultures and stocks, sharps, materials contaminated with blood and limited amounts of fluids, isolation and surgery waste, laboratory waste (excluding chemical waste) and “soft” waste (including gauze, bandages, drapes, gowns and bedding) from patient care. Volatile and semi-volatile organic compounds, chemotherapeutic waste mercury, other hazardous chemical waste and radiological waste should not be treated in an autoclave.

The operation of autoclaves requires the proper combination of temperature/pressure and exposure time to achieve disinfection, a minimum recommended temperature–exposure time criterion of for example is 121°C for 30 minutes. However, the effective penetration of steam and moist heat depends on many factors; including time, temperature/pressure, process sequence, load size, stacking configuration and packing density, types and integrity of bags or containers used, physical properties of the materials in the waste (such as bulk density, heat capacity and thermal conductivity), the amount of residual air and the moisture content in the waste. Depending on usage, regular validation tests using biological indicators should be performed at periodic intervals (typically, every week, every 40 hours of use, or once a month). As an added check, color-changing chemical indicators, such as strips that

contain thermochromic agents (chemicals that change color when they reach a given temperature) or integrators (indicators that respond to both time and temperature) can be used with each waste load to document that the required temperature has been achieved.

### General considerations in the use of autoclave

- Autoclaves are generally not used for large anatomical remains (body parts), because it is difficult to determine beforehand the time and temperature parameters needed to allow full penetration of heat to the center of the body part. With sufficient time and temperature, it is technically possible to treat small quantities of human tissue, but ethical, legal, cultural, religious and other considerations may preclude their treatment.
- Volatile and semi-volatile organic compounds, chemotherapeutic waste, mercury, another hazardous chemical waste, and radiological waste should not be treated in an autoclave.
- Large and bulky bedding material, large animal carcasses, sealed heat-resistant containers and other waste loads that impede the transfer of heat should be avoided.
- If liquids such as blood bags or urine bags are to be sterilized, the sterilization process and time have to be adapted. As a guide, 134°C for 60 minutes is recommended for exceptionally resistant microorganisms.

- **Reference:** Global Healthcare Waste Project, Module15: Non-Incineration Treatment and Disposal of Healthcare
- **Waste:** [https://www.who.int/water\\_sanitation\\_health/facilities/waste/module15.pdf?ua=1](https://www.who.int/water_sanitation_health/facilities/waste/module15.pdf?ua=1)

### B. Autoclave with Integrated Shredders

This is sometimes referred to as advanced autoclave, hybrid autoclave, or advanced stream treatment technology. This system functions as an autoclave combined with various mechanical processes; before, during, or after steam treatment. The purpose is to improve the transfer of heat into the waste, achieving more uniform heating of the waste, rendering the waste unrecognizable and/or making the treatment system a continuous process. Volatile and semi-volatile organic compounds, chemotherapeutic waste mercury, other hazardous chemical waste and radiological waste should not be treated thru this technology.

### C. Microwave Treatment Technology

Microwave technology is essentially a steam-based process where treatment occurs through the action of moist heat and steam generated by microwave energy. Water contained in the waste is rapidly heated by microwave energy at a frequency of about 2450 MHz and a wavelength of 12.24cm. In general, microwave-treatment systems consist of a treatment area or chamber into which microwave energy is directed from a microwave generator (magnetron). Generally, 2 to 6 magnetrons are used with an output of about 1.2 kW

each. Some systems are designed as batch processes and others are semi-continuous).

- The types of waste commonly treated in microwave systems are identical to those treated in autoclaves: cultures and stocks, sharps, materials contaminated with blood and body fluids, isolation and surgery waste, laboratory waste (excluding chemical waste) and soft waste (e.g., gauze, bandages, gowns and bedding) from patient care.
- One microwave system has been successfully tested with animal waste and can potentially be used to treat pathological waste such as tissues).
- Volatile and semi-volatile organic compounds, chemotherapeutic waste mercury, other hazardous chemical waste and radiological waste should not be treated in a microwave. A fully enclosed microwave unit can be installed in an open area and, with a High-Efficiency Particulate Air (HEPA) filter to prevent the release of aerosols during the feed process, the odor is somewhat reduced, except near the microwave unit.

#### D. Dry Heat Treatment Technology

In dry-heat processes, heat is applied without adding steam or water. Instead, the waste is heated by conduction, natural or forced convection, or thermal radiation. In forced convection heating, air heated by resistance heaters or natural gas is circulated around the

waste in the chamber. In some technologies, the hot walls of the chamber heat the waste through conduction and natural convection. Other technologies use radiant heating using infrared or quartz heaters.

Circulating hot-air ovens have been used to sterilize glassware and other reusable instruments for many years. This concept of dry-heat treatment has been applied to the treatment of infectious health waste more recently. As a general observation, dry-heat processes use higher temperatures and longer exposure times than steam-based processes. They are not commonly used in large-scale facilities with a high volume of wastes. Microorganisms like bacillus atrophaeus spores are known to be resistant to dry heat and are commonly used as a microbiological indicator to measure the effectiveness of dry-heat technologies. Volatile and semi-volatile organic compounds, chemotherapeutic waste mercury, other hazardous chemical waste and radiological waste should not be treated thru this technology.

#### E. Chemical Treatment Technology

##### Chemical Disinfection

Chemical disinfection is used routinely in HCFs to destroy or inactivate microorganisms on medical equipment and floors and walls, and now its use is being extended to the treatment of HCW. This treatment usually results in disinfection rather than sterilization. Chemical disinfection is most suitable for treating liquid HCW such as blood, urine, stools, or hospital sewage.

Manual systems using chemical disinfection are not regarded as reliable methods for treating waste. Chemical disinfection is usually carried out on HCF premises;

however, commercial, self-contained, and fully automatic systems have recently been developed for HCW treatment and are being operated away from medical centers at industrial zones. However, in developed countries, chemical disinfection is still the duty of HCFs and it is carried out within the premises.

Subsequently, the disinfected waste requires specialized disposal.

**In the application of chemical disinfection, the following must be considered by the HCF:**

- The types of chemicals used for the disinfection of HCW are mostly chlorine compounds, aldehydes, lime-based powders or solutions, ozone gas, ammonium salts and phenolic compounds. Formaldehyde and ethylene oxide are no longer recommended for waste treatment due to significant hazards related to their use.
- Studies showed that chlorine-based technologies using sodium hypochlorite and chlorine dioxide as well as its by-products in wastewater might have long-term environmental effects.
- Non-chlorine-based technologies are quite varied in the way they operate and the chemical agents they employ. Others use peroxyacetic acid, ozone gas, lime-based dry powder, acid and metal catalyst or biodegradable disinfectants. Occupational and safety exposures shall be monitored when using the chemical process.

- Some disinfectants are effective in killing or inactivating specific types of microorganisms, and others are effective against all types. It is therefore important to know the identity of the target microorganisms to be destroyed.
- Users of chemical disinfectants should consider their stability and shelf life. Some disinfectants are stable for several years and can remain effective for months after opening the container. Other disinfectants degrade quickly.
- Powerful disinfectants are often hazardous and toxic, and many are harmful to skin and mucous membranes.
- Users should therefore be aware of their physiological effects and wear protective clothing, including gloves and protective eyeglasses or goggles. Disinfectants are also aggressive to certain building materials and should be handled and stored according to manufacturers' instructions.
- Microbial resistance to disinfectants has been investigated, and it is possible to list the major groups of microorganisms from most to least resistant as follows: bacterial spores, mycobacteria, hydrophilic viruses, lipophilic viruses, vegetative fungi and fungal spores; and vegetative bacteria.
- In planning the use of chemical disinfection, requirements for the eventual disposal of the residues should be carefully considered. Improper disposal could give rise to serious environmental problems.

## Alkaline Hydrolysis

Alkaline hydrolysis or digestion is a process that converts animal carcasses, human body parts and tissues into a decontaminated aqueous solution. The alkali also destroys fixatives in tissues and various hazardous chemicals, including formaldehyde, glutaraldehyde, and chemotherapeutic agents.

The technology is designed for tissue wastes including anatomical parts, organs, placenta, blood, body fluids, specimens, human cadavers, and animal carcasses. The process has been shown to destroy prion waste. The by-products of the alkaline digestion process are biodegradable mineral constituents of bones and teeth (which can be crushed and recovered as sterile bone meal) and an aqueous solution of peptide chains, amino acids, sugars, soaps, and salts.

The technology uses a steam-jacketed, stainless-steel tank and a basket. After the waste is loaded in the basket and into the hermetically sealed tank, alkali (sodium or potassium hydroxide) in amounts proportional to the quantity of tissue in the tank is added, along with water. The contents are heated to between 110°C and 127°C or higher and stirred. Depending on the amount of alkali and temperature used, digestion times range from six to eight hours. Alkaline hydrolysis units have been designed to treat from 10 to 4500kg per batch. The technology has been approved for the destruction of prion waste when treated for at least six hours.

## F. High-temperature Processing Technologies

### Incineration

Incineration is a high temperature, dry oxidation process that reduces organic and combustible waste to inorganic, incombustible matter, and results in a significant reduction of waste volume and weight. High-heat thermal processes take place at temperatures from about 200°C to more than 1000°C. They involve the chemical and physical breakdown of organic material through the processes of combustion, pyrolysis, or gasification.

Per the Stockholm Convention, the best available technology (BAT) should be used to achieve emission of lower than 0.1ng TEQ/m<sup>3</sup> of dioxins and furans. The primary requirements of incinerators stated are:

- two burning chambers (850°C/1100°C),
- auxiliary burner,
- two seconds' residence time of air in the second chamber,
- sufficient oxygen content, and
- high turbulence of exhaust gases.

The primary measures described here should be a minimum standard. By applying primary measures, a performance of around 200ng TEQ/m<sup>3</sup> of dioxins and furans can be achieved. This minimum standard should be followed by an incremental improvement approach, with which the requirements of the Stockholm Convention can be reached. To achieve emissions lower than 0.1ng TEQ/m<sup>3</sup>, additional flue gas treatment systems are needed (secondary measures). These may be comparatively expensive for small and medium-sized incinerators, and this should be taken into consideration at the planning stage. Furthermore, air filters and wastewater resulting from the filtering processes are considered as hazardous waste and need to be handled accordingly.

There are few small and medium-sized incinerators available on the market, which operate per the Stockholm Convention. A

simplified flow diagram of an incineration process with flue gas is indicated in Figure.

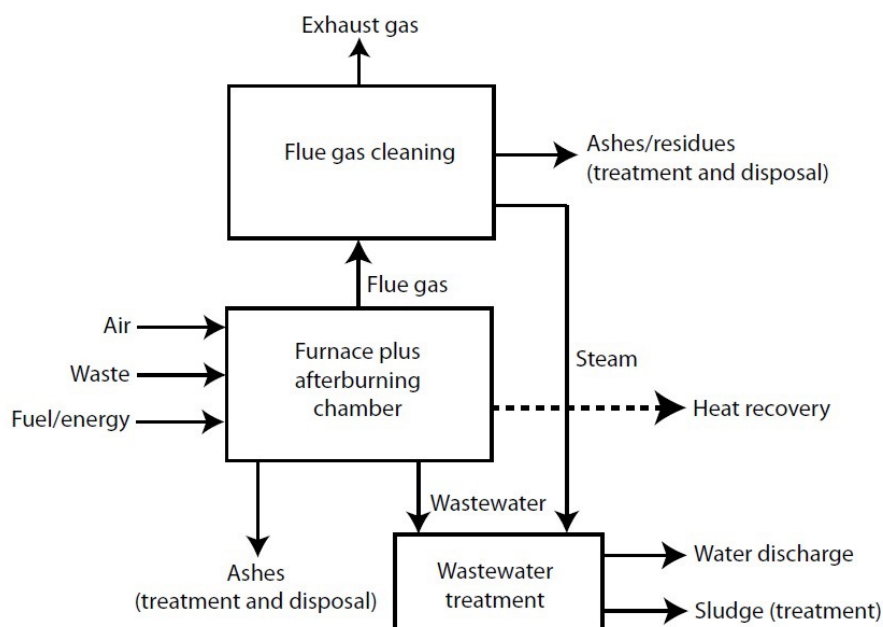

**Figure 5. 9: Schematic flow of incineration process (UNEP, 2006)**

High-tech incinerators require reliable controls of combustion parameters, a flue gas cleaning system (dust removal, ceramic filters, cyclonic scrubbers, and electrostatic precipitators) and wastewater treatment.

Burning HCW without flue gas treatment releases a wide variety of pollutants into the atmosphere, according to the composition of the waste. These pollutants may include particulate matter such as fly ash, heavy metals (arsenic, cadmium, chromium, copper, mercury, manganese, nickel, and lead), acid gases (hydrogen chloride, hydrogen fluoride, Sulphur dioxides, and nitrogen oxides), carbon monoxide, and organic compounds (including dioxins and furans, benzene, carbon tetrachloride,

chlorophenols, trichloroethylene, toluene, xylenes, trichloro-trifluoroethane, polycyclic aromatic hydrocarbons, vinyl chloride).

If HCW is incinerated in conditions that do not constitute the best available techniques or best environmental practices, there is potential for the release of dioxins and furans in relatively high concentrations. Dioxins and furans are bio-accumulative and toxic. Pathogens can also be found in solid residues and the exhaust gases and particulates of poorly designed and badly operated incinerators. In addition, the bottom ash residues can be contaminated with dioxins, leachable organic compounds, and heavy metals and should be treated as hazardous waste.

## Small-scale incineration

Small-scale incinerators are alternatives for small and medium HCFs in Ethiopia. These incinerators are designed to meet an immediate need for public health protection where there is no access to more sophisticated technologies. This involves a compromise between the environmental impacts from controlled combustion and an overriding need to protect public health if the only alternative is indiscriminate dumping. As far as possible, a small-scale facility should avoid burning PVC plastics and other chlorinated waste.

If small-scale incinerators are the only option available, the best practices possible should be used, to minimize operational impacts on the environment.

### Best practices for small-scale incinerators:

- Effective waste reduction and segregation, ensuring only the smallest quantities of combustible waste types are incinerated;
- An engineered design with sufficient residence time and temperatures to minimize products of incomplete combustion;
- Siting incinerators away from health-care buildings and residential areas or where food is grown;
- Construction using detailed engineering plans and materials to minimize flaws that may lead to incomplete destruction of waste and premature failures of the incinerator;

- A clearly described method of operation to achieve the desired combustion conditions and emissions;
- Periodic maintenance to replace or repair defective components (including inspection, spare parts inventory and daily record keeping);
- Improved training and management, possibly promoted by certification and inspection programs for operators, the availability of an operating and maintenance manual, visible management oversight, and regular maintenance schedules.

## Pyrolysis and gasification

Pyrolysis and gasification processes operate with substoichiometric air levels. It is the thermal decomposition of HCW in the absence of supplied molecular oxygen, in the destruction chamber, in which the HCW is converted into a gaseous, liquid, or solid form. Pyrolysis can handle the full range of HCW. Waste residues may be in form of greasy aggregates or slugs, recoverable metals, or carbon black. These residues are disposed of in a landfill.

### G. Emerging Technologies

Developing and emerging technologies should be carefully evaluated before selection for routine use because most do not have a demonstrable record of accomplishment in HCW application.

## Ozone

Ozone (O<sub>3</sub>) can be used for disinfecting waste. Ozone gas is a strong oxidizer and breaks down easily to a more stable form (O<sub>2</sub>). Ozone systems require shredders and mixers to expose the waste to the bactericidal agent. Ozone has been used for water treatment and air purification. At concentrations greater than 0.1 ppm, ozone can cause eye, nose, and respiratory tract irritation. As with other chemical treatment technologies, regular tests should be conducted to ensure that the microbial inactivation standard is met.

## Plasma Pyrolysis

Plasma pyrolysis makes use of ionized gas in the plasma state to convert electrical energy to temperatures of several thousand degrees using plasma arc torches or electrodes. The high temperatures are used to pyrolyze waste in an atmosphere with little or no air.

## Promession

Promession is a new technology that combines a mechanical process and the removal of heat to destroy anatomical waste. It involves cryogenic freeze-drying using liquid nitrogen and mechanical vibration to disintegrate human remains into powder before burial. The process speeds up decomposition, reduces both mass and volume, and allows the recovery of metal parts.

## Pyroclave

The process involved in a pyroclave is a combination of pyrolysis and autoclave. The pyroclave can disinfect and reduce the mass and volume of the medical wastes by 95%. Like pyrolysis, wastes are thermally decomposed without direct contact to fire

and the presence of oxygen. HCW is placed inside a sealed rotating chamber. The pyroclave operates in intense heat (up to 1,200°C) to carbonize the HCW. A synthesized gas called “syngas”, produced by the intense heat and decomposition process is recycled and fed into the burners, thereby serving as added fuel to continue the process and help boost combustion. Through this process, disinfection, carbonization, and decomposition can be accomplished.

## Superheated steam

Superheated steam at 500°C can be used to break down infectious, hazardous chemical or pharmaceutical wastes. The vapors are then heated further in a steam-reforming chamber to 1500°C. This technology is expensive, and – like incineration – requires pollution control devices to remove pollutants from the exhaust gas.

## H. Onsite HCW Treatment Facilities

In Ethiopia, most HCFs are forced to operate their HCW treatment facility because of the absence of centralized HCW treatment facilities. In such circumstances, the following factors must be considered for the location of the treatment facilities:

### Consideration for onsite HCW treatment facilities

- Safe transfer routes must be provided from the storage area to the treatment facility;
- The HCW treatment facilities must be located within the HCF. However, the area must be located away from the dietary section, patient



rooms, laboratories, hospital function/operation rooms or any public access areas;

- The facilities should be located in a way that it does not produce nuisances such as odor, noise, the visual impact of HCW operations on patients and visitors;
- Public access and security are provided;
- Consider the proximity of the treatment facility to the temporary or central storage;
- Be strategically placed so as not to cause traffic problems in the entry and exit of vehicles;
- Consider the volume of waste generated by the HCF when it comes to the size of the treatment facility;
- Be protected from rain, strong winds, floods, etc.;
- Have elevated, concrete finish flooring and with waterproofing, adequately sloped for easy cleaning;
- Have a good drainage system and connected to a WWTP.
- Have a continuous water supply for cleaning purposes.
- Have locking device to prevent access by unauthorized persons.
- Be inaccessible to animals, insects, and birds.
- Have adequate ventilation and lighting
- Have supplies of cleaning implements (e.g., hose with spray nozzle, scrubber with a long

handle, disinfectant, protective clothing, waste bags or bins) and fire-fighting equipment/devices located conveniently close to the storage area.

- Have space allowances needed by workers to maneuver safely around the treatment facility.
- Have floors, walls, and ceilings that are clean at all times.
- Have a warning sign and symbol posted in a strategic place:  
“CAUTION: TREATMENT AREA:  
UNAUTHORIZED PERSONS KEEP  
OUT.”

## 5.4 HCW disposal

### 5.4.1 Encapsulation

Encapsulation is a method of HCW disposal for HCFs, which have available resources, and technical personnel for the process. It involves filling containers with waste, adding an immobilizing material, and sealing the containers. The process uses either cubic boxes made of high-density polyethylene or metallic drums, which are three-quarters filled with sharps or chemical or pharmaceutical residues. Then, the containers or boxes are filled up with a medium; such as plastic foam, bituminous sand and cement mortar. After the medium has dried, the containers are sealed and disposed of in a landfill.

This process, where the encapsulation materials are available, is appropriate for establishments for the disposal of sharps and chemical or pharmaceutical residues. Encapsulation alone is not recommended for non-sharps waste but may be used in

combination with the treatment of such waste. The main advantage of the process is its effectiveness in reducing the risk of scavengers gaining access to the hazardous HCW.

### 5.4.2 Inertization – Stabilization/ Solidification

Inertization involves mixing waste with cement and other substances before disposal to minimize the risk of toxic substances contained in the waste migrating into surface water or groundwater.

Inertization can be by the process of stabilization or solidification. Stabilization refers to the chemical changes of the hazardous substances in the waste while solidification means physical immobilization of the hazardous substances to reduce the vaporization or leaching to the environment.

This process is especially suitable for pharmaceuticals and for incineration ashes with a high metal content (in this case, the process is called “stabilization”). For the inertization of pharmaceutical waste, the packaging should be removed, the pharmaceuticals ground, and a mixture of water, lime and cement added. A homogeneous mass is formed, and cubes or pellets are produced on-site. Subsequently, these can be transported to a suitable storage site. Alternatively, the homogeneous mixture can be transported in a liquid state to a landfill and poured onto the surface of previously landfilled municipal waste, then covered with fresh municipal waste. The typical proportion (by weight) of inertization mixture can be 65% pharmaceutical waste, 15% lime, 15% cement and 5% water.

The process is reasonably inexpensive and can be performed using relatively unsophisticated mixing equipment. Other than personnel, the main requirements are a grinder or road roller to crush the pharmaceuticals, a concrete mixer and supplies of cement, lime, and water.

### 5.4.3 Sharps Pit/Concrete Vault

This method is especially suitable for the disposal of used sharps and syringes. The collected safety boxes filled with used sharps and needles will be deposited inside the concrete vault. Figure 5.10 shows a sample concrete vault design.

#### **The following shall be observed when constructing the concrete vault:**

- The site is isolated and at least 150 meters away from the water supply sources and dwelling units.
- Dig a pit (minimum size of 1m x 1m x 1.8m depth) enough to accommodate sharps/syringes for an estimated period without reaching the groundwater level.
- Construct concrete walls and slabs of the pit.
- Provide slab with opening/ manhole for easy deposition of collected sharps and syringes. The manhole shall be extended a few centimeters above the soil surface to overcome infiltration of surface water.
- Install a security fence around the site with signage.

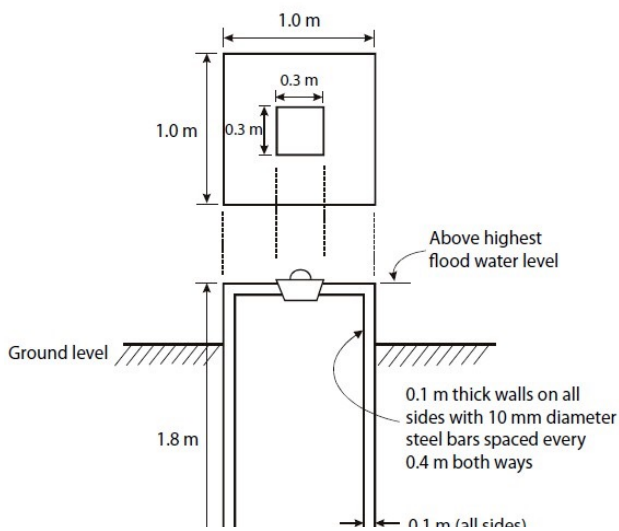

**Figure 5. 10: Sample sharp waste concrete vault**

#### 5.4.4 Placenta Pit

In many communities of Ethiopia and other parts of the world, burying placentas is an important ritual and one option for disposal. If it is done safely, burial can protect the community from pathogens while respecting cultural norms and religious traditions. The disposal of the placenta can use concrete pits. The process of biodegradation in the pit can destroy pathogenic microorganisms as the waste is subjected to changes in temperature, pH, and a complex series of chemical and biological reactions. The degradation processes in a pit are anaerobic, with some aerobic decomposition in the upper layers where oxygen is available for aerobic bacteria. The waste should not be treated with chemical disinfectants such as chlorine before being disposed of, because these chemicals destroy the microorganisms that are important for biological decomposition.

#### In selecting the location of the placenta pit, the following should be considered:

- Should be as far away as possible from publicly accessible areas and hygienically critically areas (e.g., water wells, kitchens);
- Placenta pits should not be built too close to buildings due to possible odors;
- A safety distance of at least 1.5 meters from the bottom of the pit to the groundwater level is recommended; and
- Placenta pits are not recommended in sites where the water table is near the surface or in areas prone to flooding.

1. **Pit:** string line, sticks and measuring tape
2. **Slab:** shovel, hoe, pickaxe, miner's bar
3. **Lid:** fired bricks or cement blocks
4. **Base or lining:** sand, cement, gravel and clean water
5. **Permeable soil:** reinforcement bars (diameter 8 mm)
6. **Drainage channel:** tools to prepare and cast concrete; masons' tools
7. **Mortar layer (at least 10 mm thick):** jute sacking or plastic sheeting
8. **Ventilation pipe:** prefabricated slab with lid
9. **Tee with mosquito netting:** protective clothing for operators
10. **Water table:** polyvinyl chloride (PVC) pipe (preferably diameter 150 mm), piece of stainless steel or nylon mosquito net

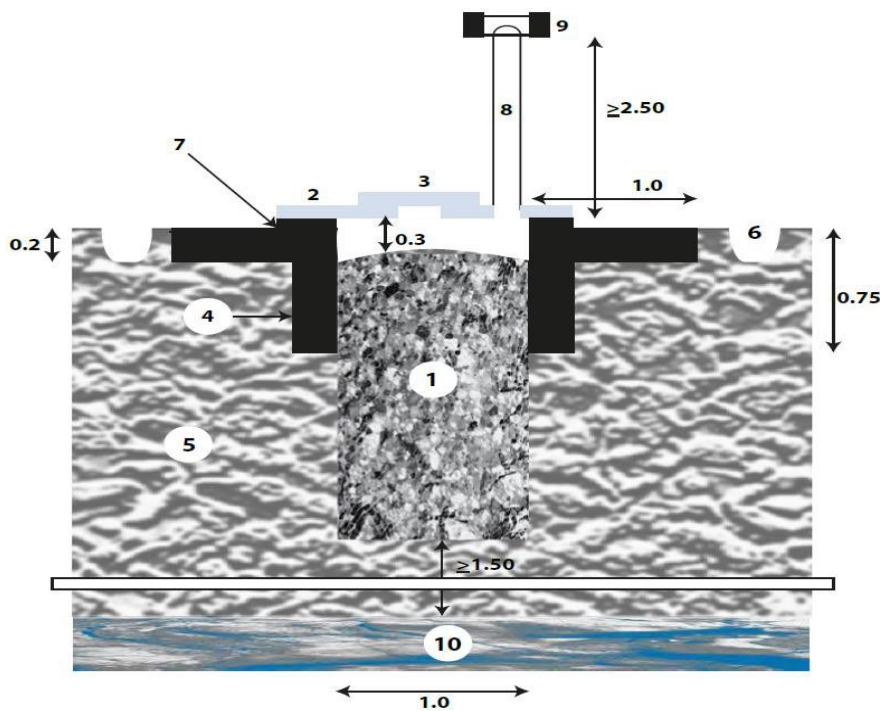

**Figure 5.11: Sample design of placenta pit**

The dimensions of the pit will be context-specific and will depend on the average number of births and infiltration rate of the soil. In principle, allow 0.5 liters of soil infiltration per placenta, and a maximum of 5 liters of total space per placenta if all the bloody liquids are collected and no infiltration is occurring.

It is recommended that two placenta pits be built so that the second one is available as soon as the first is filled. Once a pit is filled up, it should be closed. Any sealed pits should be marked, and their locations recorded. However, it may be possible to reopen pits after enough time has passed and the material has been degraded. When pits are reopened, it may be necessary to remove some of the degraded material.

#### **5.4.5 Safe On-site burial at HCF Located in rural areas**

Safe burial of HCW within the HCF as a disposal method applies only to treated infectious waste, sharps waste, pathological and anatomical waste, small quantities of encapsulated/inertized solid chemical and pharmaceutical wastes. Safe burial may be implemented but should be considered a transitional, interim solution.

#### **Safe burial of HCW shall only be allowed in the following situations:**

- HCF is located in a remote and far-flung area with no self-income source;
- HCF does not have access to central disposal facilities;
- In larger HCFs and hospitals, the safe burial of HCW within the HCF premises is the only viable option at a specific time, e.g.,

temporary refugee encampments, in emergencies and areas experiencing exceptional hardship.

- The following shall be the characteristics for the safe burial site:
- Not located in flood-prone areas;
- Downhill or down-gradient from any nearby wells and about 50 meters away from any water body such as rivers or lakes to prevent contaminating water source; new water wells should not be dug near the disposal pit;
- Bottom of the pit located at least 1.5 meters above ground water level;
- Secured (e.g., fenced with warning signs); accessible only to authorized personnel;
- Lined with a material of low permeability, such as clay or HPDE, to prevent pollution of shallow groundwater that may subsequently reach nearby wells;
- Allow only hazardous HCW to be buried. If general HCW is also buried on the premises, available space would be quickly filled up;
- Managed as a landfill, with each layer of waste covered with a layer of earth to prevent odor, as well as to prevent the proliferation of rodents and insects; and
- Larger quantities (<1kg) of chemical wastes should not be buried at one time; however, burying small quantities occasionally is less likely to create adverse pollution.

## 5.4.6 Land disposal

In all waste systems, the removal of the remaining health-care waste materials after minimization or treatment will require access to land for final disposal. In less developed areas, where a municipality or health-care facility lacks the means to treat wastes before disposal, the direct use of a landfill is likely to be required for much of the material produced. The alternative is often an accumulation of healthcare waste at medical facilities where it is openly burnt or spread indiscriminately around the facility's grounds. This constitutes a far higher risk of transmission of infection than controlled disposal in a land disposal site; even if the land disposal site is not designed to the precise standards used in higher-income places.

There are two distinct types of waste disposal namely uncontrolled dumping and control landfilling.

### Uncontrolled dumping

Uncontrolled dumping is characterized by the scattered, uncontrolled deposit of wastes at a site. This practice usually leads to acute pollution problems, fires, higher risks of disease transmission and open access to scavengers and animals. Health-care waste should not be deposited on or around uncontrolled dumps. The risk to people and animals being exposed to infectious pathogens or hazardous materials is obvious, with the further risk of subsequent disease transmission through direct contact, wounds, inhalation or ingestion, as well as indirectly through the food chain or a pathogenic host species. Therefore, uncontrolled dumping, as much as possible should not be considered as an alternative for HCW disposal.

## Controlled landfilling (Sanitary landfilling)

HCW that is properly treated with the applicable technology as stated in this guideline can be disposed of in a sanitary landfill but must not be mixed with the municipal wastes. Controlled landfilling represents various types of disposal to land characterized by better operating practices and design improvements to reduce health and environmental impacts. The first step to improvement is “controlled dumping”, where small improvements can restrict environmental consequences and physical access to waste. This is followed by “engineered landfill” where increasing standards of engineering are used to improve geological isolation of wastes from the environment and to allow wastes to be covered daily. Disposing of certain types of health-care waste (infectious and small quantities of pharmaceutical wastes) in engineered landfills is possible within the constraints of local regulations. A well-engineered landfill is designed to minimize contamination of soil, surface water and groundwater; limit atmospheric releases and odors; block access to waste by pests and vectors; and prevent contact with the public. Where skills and resources are available, still higher standards of site preparation are possible to achieve a “sanitary landfill”, with trained staff and specialized equipment present onsite to manage operations.

### The landfill shall:

- Be accessible to site and working areas for easy passage of delivery access;
- Have landfill personnel capable of effective control of daily operations;

- Divide the site into manageable phases, which are appropriately prepared, before disposal of wastes;
- Have adequate sealing of the base and sides to minimize the movement of wastewater (leachate);
- Have adequate mechanisms for leachate collection and treatment systems;
- Have an organized deposit of waste in a small area, allowing waste to be spread, compacted, and covered daily;
- Have surface water collection trenches around site boundaries;
- Have a construction of a final cover to minimize rainwater infiltration when each phase of the landfill is completed.

Certain types of HCW, such as anatomical waste, in a landfill may be culturally or religiously unacceptable in many countries. Such wastes should be placed in approved burial grounds or cremated. If this is not possible, these wastes could be placed in containers or rendered unrecognizable before disposal.

### Safe burial on HCF’s premises

Safe burial in the HCF’s compound is the minimal approach to health-care waste management that needs to be used in remote health-care facilities and underdeveloped areas. In addition, minimal practices may also be necessary for temporary refugee encampments and areas experiencing exceptional hardship. Consequently, the safe

burial of waste on hospital premises may be the only viable option available at that time. Even in these difficult circumstances, the HCF's management can establish the following basic principles:

- Access to the disposal site should be restricted to authorized personnel only.
- The burial site should be lined with a material of low permeability, such as clay, dung and river silt, if available, to prevent pollution of shallow groundwater and nearby wells.
- New water wells should not be dug near the disposal pit.
  
- Only infectious health-care waste should be buried (if general hospital waste was also buried on the premises; available space would be quickly filled).
- Larger quantities (<1 kg) of chemical wastes should not be buried at one time; however, burying small quantities occasionally is less likely to create adverse pollution.
- The burial site should be managed as a landfill, with each layer of waste covered by a layer of soil to prevent odors and contact with the decomposing waste, and to deter rodents and insects.

**Table 5. 2: Summary of HCW disposal options for each HCW types**

Category of HCW	Treatment/Disposal Method Options
Sharps	<p><b>Disinfection:</b> Autoclave, Microwave technology, Chemical disinfection</p> <p><b>Mechanical shredding:</b> On-site mechanical needle cutters or electric needle destroyers</p> <p>Encapsulation in cement blocks</p>
Sharps pits/Concrete vaults	
Anatomical waste, pathological waste, placenta waste and contaminated animal carcasses	<p>Burning in crematoria or specially designed incinerators</p> <p>Alkaline digestion, especially for contaminated tissues and animal carcasses</p> <p>Promession (freeze-drying)</p> <p>Interment (burial) in cemeteries or special burial sites</p> <p>Placenta waste is composted or buried in placenta pits designed to facilitate natural</p>
Biological decomposition.	

Category of HCW	Treatment/Disposal Method Options
Pharmaceutical waste	<p>Return to the original supplier (preferred option)</p> <p><b>Encapsulation</b></p> <p>Chemical decomposition per the manufacturer’s recommendations if chemical expertise and materials are available;</p> <p>Dilution in large amounts of water and discharge into a sewer for moderate quantities of relatively mild liquid or semi-liquid semi-liquid pharmaceuticals, such as solutions containing vitamins, cough syrups, intravenous solutions and eye drops and harmless liquids such as intravenous fluids.</p> <p>Incineration in kilns equipped with pollution-control devices designed for industrial waste and that operate at high temperatures;</p> <p>Dilution and sewer discharge for relatively harmless liquids such as intravenous fluids (salts, amino acids, glucose).</p> <p>Sanitary landfill for non-hazardous pharmaceutical waste</p>
Cytotoxic Waste	<p>Incineration at high temperatures with gas-cleaning equipment</p> <p>Chemical degradation following the manufacturers’ instructions.</p> <p>Alkaline hydrolysis</p> <p>Encapsulation or inertization may be considered as a last resort</p> <p>Return to the original s supplier (preferred option)</p>
Chemical Waste	<p>Large amounts of chemical waste should not be buried, because they may leak from their containers, overwhelm the natural attenuation process provided by the surrounding waste and soils and contaminate water sources.</p> <p>Encapsulation. (Large amounts of chemical disinfectants should not be encapsulated, because they are corrosive to concrete and sometimes produce flammable gases)</p> <p>Where allowed by local regulations, non-recyclable, general chemical waste, such as sugars, amino acids and certain salts, may be disposed of with municipal waste or discharged into sewers.</p> <p>An option for disposing of hazardous chemicals is to return them to the original supplier, who should be equipped to deal with them safely</p> <p>Sanitary landfill (for small quantities only)</p>



Category of HCW	Treatment/Disposal Method Options
Waste containing heavy metals	<p>Wastes containing mercury or cadmium should not be burned or incinerated.</p> <p>Cadmium and mercury volatilize at relatively low temperatures and can cause atmospheric pollution.</p> <p>If none of the above options were feasible, the wastes would have to go to a disposal or storage site designed for hazardous industrial waste.</p> <p>Send back the waste to the suppliers of the original equipment, to reprocess or final disposal</p>
Radioactive Waste	<p>Return to supplier</p> <p>“Decay in storage”, which is the safe storage of waste until its radiation levels are indistinguishable from background radiation; a general rule is to store the waste for at least 10 times the half-life of the longest-lived radionuclide in the waste.</p> <p>Long-term storage at an authorized radioactive waste disposal site.</p> <p>It is not appropriate to disinfect radioactive solid waste by wet thermal or microwave procedures</p> <p>Disposable syringes containing radioactive residues should be emptied in a location designated for the disposal of radioactive liquid waste. Syringes should then be stored in a sharps container to allow decay of any residual activity before normal procedures for disposal of syringes and needles are followed.</p> <p>Higher-level radioactive waste of relatively short half-life (e.g., from iodine-131 therapy) and liquids that are immiscible with water, such as scintillation-counting residues and contaminated oil, should be stored for decay in marked containers, under lead shielding, until activities have reached authorized clearance levels.</p> <p>Radioactive waste resulting from cleaning-up operations after a spillage or other accident should be retained in suitable containers unless the activity is low enough to permit immediate discharge.</p>

## 5.5 Overview of treatment and disposal of HCW in primary care facilities

Treatment of wastes mainly aims at reducing direct exposure of humans, recovering recyclable materials, and protecting the environment. For wastes from the primary care facilities, the main aim is to disinfect infectious waste, to destroy disposable medical devices, in particular used syringe needles, which should not be reused, or at least to render them inaccessible or sterile prior to plastic reprocessing. The table below (Table 5.3) shows the different possible treatments of different HCW.

**Table 5. 3: Possible treatment options for HCW**

Treatment/ Disposal Options	Non-plastic Infectious	Anatomical Waste	Sharps Waste	Pharmaceutical Waste	Chemical Waste
Waste Burial	Waste Yes <sup>1</sup>	Yes <sup>1</sup>	Yes <sup>1</sup>	Small quantities	Small quantities
Sharp pit	No	No	Yes <sup>1</sup>	Small quantities	No
Placenta pit	No	Yes <sup>1</sup>	No	No	No
Encapsulation	No	No	Yes	Yes	Small quantities
Inertization	No	No	No	Yes	No
Low temp burning (< 800°C)	Yes (interim solution)	Yes (interim solution)	No	No	No
Med temp burning (800 – 1000°C)	Yes	Yes	Yes	No	No
High temp burning (> 1000°C)	Yes	Yes	Yes	Small quantities	Small quantities
Steam autoclave	Yes	No	Yes	No	No
Microwave	Yes	No	Yes	No	No
Chemical	Yes	No	Yes	No	No
Discharge to Sewer	No	No	No	Only non-hazardous	Small quantities
Others		Return expired drugs to supplier		Return unused chemicals to supplier	

Note: <sup>1</sup>Waste should be disinfected first

Source: *Management of Solid Healthcare Waste at Primary Health-Care Centers (WHO, 2005)*

## 5.6 Management of wastes from home care services

Home care wastes are typically the type of wastes normally encountered in routine home health-care and emergency pandemics like COVID 19, which include needles, syringes, lancets, other sharp objects, soiled bandages, gauze, disposable sheets, tubing, and used medical gloves. The improper disposal of contaminated sharps is a serious safety concern for garbage collectors and landfill workers. If improperly thrown in trash bags along with regular trash, these sharps can puncture the bags and cause injury. The disposal of clinical waste in a patient's home, where the patient is treated by a community nurse or a health-care professional, is the responsibility of the nurse/health-care professional giving the treatment. The health-care professional / nurse needs to ask permission from the homeowner prior to disposing of waste into their rubbish bin. Hospitals and other HCFs must provide instructions to the family and relatives of the patient prior to approval for home care, the basic information on homecare waste management and disposal. Further, homecare waste management and disposal shall be monitored by the local health authorities in the area.

### **The following must be observed for the proper management and disposal of HCW from home care:**

- Dispose of lancets, syringes and other sharp objects separately by placing them in hard plastic or metal containers with screw-on or tightly secured lid. Many containers found in the household will do.
- Before disposal, the tightly sealed lead must be reinforced with heavy-duty tape and labeled "NOT FOR RECYCLING".
- Do not place sharps in glass containers and those intended for re-use or recycling. Containers should have a small opening so that no one else can stick their hand into them.
- Do not recap, purposely bend, break, or otherwise manipulate needles before inserting them into the disposal container.
- Sharps should be disposed of once the container is three-quarters full. Be sure to keep all containers with discarded sharps of reach of children and pets. Drop all parts into the container. Before disposal, the tightly sealed lead must be reinforced with heavy-duty tape and labeled "NOT FOR RECYCLING".
- Other hazardous infectious materials such as soiled bandages, gloves, disposable sheets must be placed in securely fastened yellow plastic bags prior to disposal.
- If the waste is classified as hazardous in the patient's home, the health-care professional can remove that waste, transport it into approved containers (i.e. rigid, leak-proof, sealed, secured, etc.), and take it to the nearest HCF with HCW disposal units. The caregivers who are family members can also do the same procedure to dispose of hazardous and infectious waste ensuring always to follow the required type of containers.

- In the case of home health-care for COVID 19 suspected or confirmed cases, every waste generated from the service should be considered infectious waste.

**Source:** Adapted from “Disposal Tips for Home Healthcare” (USEPA, 1998)

## 5.7 Management of wastes from immunization campaign activities

Immunization activities at outreach sites generate sharps and infectious non-sharp wastes that should be properly managed on-site to avoid or reduce its negative health impacts on the community and the personnel working.

### Waste Segregation and Packaging

- Always segregate sharps from non-sharps at the source
- Immediately after use, discard the entire syringe with the needle into a safety box without recapping needles
- Put safety boxes into plastic bags closed hermetically when full to avoid any leakage during transportation.
- Mark the bag clearly.
- Put empty vials into waste containers with plastic lining to avoid leakage. Seal/mark clearly when full.
- Waste Treatment and Final Disposal for Sharps (needles with a syringe)
- Prepare a sufficient number of sharps safety boxes for the day;
- Discard entire syringe and needle immediately after vaccination in safety box without recapping;
- When the sharps safety box is three-quarters full, put it aside and make sure that waste handlers close, seal it with adhesive tape and mark it before putting it in a plastic bag.
- Place plastic bags carefully in the storage area or take them to the disposal system if ready to process immediately.
- For Infectious non-sharps (empty or expired vials)
- Prepare sufficient numbers of waste containers with plastic lining for the day;
- Put empty vaccine flasks and cotton swabs in the waste container;
- Once nearly full, put it aside and make sure that waste handlers close, seal it with adhesive tape and mark it before taking it away to the storage or disposal area

**Source:** Management of wastes from immunization campaign activities (WHO, 2004)

# 6 Wastewater management in health-care facilities

The various services in HCFs generate wastewater in addition to the huge quantity of solid waste. HCFs must have their own wastewater treatment facility or must be connected to a municipal or common wastewater treatment facility or an equivalent system for small HCFs. In some cases, when it is possible, the HCF must provide pretreatment to the wastewater prior to discharge to the municipal sewer.

Sufficient sanitation facilities must be provided in the HCF. The recommended minimum is one toilet per 20 users for inpatient medical areas and at least four toilets per outpatient location.

## 6.1 Composition of HCF Wastewater

Health-care wastewater is any water that has been adversely affected in quality during the provision of health-care services. It is mainly liquid waste, containing some solids produced by humans (staff and patients) or during health-care-related processes, including cooking, cleaning, and laundry. Health-care wastewater can be divided into the following three categories:

- **Blackwater (sewage)** is heavily polluted wastewater that contains high concentrations of fecal matter and urine.
- **Greywater (sullage)** is wastewater that contains more dilute residues from washing, bathing, laboratory processes, laundry, and technical processes such as cooling or rinsing of X-ray films.

- **Stormwater** is technically not wastewater itself but represents the rainfall collected on hospital roofs, grounds, yards, and paved surfaces. This may be lost to drains and watercourses and as groundwater recharge or used for irrigating hospital grounds, toilet flushing and other general washing purposes.

## 6.2 Wastewater generation rate in HCFs

Wastewater generation in secondary- and tertiary-level hospitals is mainly measured on an inpatient ratio (liter of generated wastewater per patient treatment day).

Typical generation rates are:

- Small—medium-sized hospitals: 300–500 L per inpatient per day
- Large health-care settings: 400–700 L per inpatient per day
- University hospitals: 500–>900 L per inpatient per day

In primary health-care clinics, the rate of waste generation is often measured as the sum of the number of inpatients and outpatients. Minimum water requirement in the health-care setting, according to WHO are:

- 40–60 L per inpatient
- 5 L per outpatient
- 100 L per surgical procedure

## 6.3 Sources and Characteristics of HCF Wastewater

Wastewater from HCFs contains organic particles (feces, hairs, food, vomit, paper fibers, etc.), soluble organic material (urea, proteins, pharmaceuticals, etc.), inorganic particles (sand, grit and metal particles), soluble inorganic material (ammonia, cyanide, hydrogen sulphide, thiosulphates) and other substances. The characteristics depend on the source of origin.

*Table 6: Sources and characteristics of HCF wastewater*

HCF Department	Waste Source and Characteristics
<b>Administration and Wards</b>	Urine of patients from some wards (surgery wards, oncology, infectious disease ward, etc.) might contain higher amounts of antibiotics, cytotoxic and X-ray contrast media. These antibiotics and their metabolites are excreted with urine and feces, and end up in the wastewater stream, a problem recently recognized worldwide. Hospital wastewaters are a source of bacteria with acquired resistance against antibiotics with a level of at least a factor of 2 to 10 times higher than in domestic wastewater.
<b>Kitchen</b>	Food leftovers, waste from food processing, disinfectants and detergents, starch, grease and oil.
<b>Laundry</b>	It is where greywater is mostly produced. The wastewater often is hot, has a high pH (alkaline) and might contain high amounts of phosphate, surfactants and AOX (Absorbable organically bound halogens) if chlorine-based disinfectants are used.
<b>Operating Room and ICU</b>	Higher contents of disinfectants, detergents and pharmaceuticals. Organic content can be high due to the disposal of body fluids and rinsing liquids (suction containers).
<b>Laboratories</b>	Halogenated and organic solvents, colorants from the histology and hematology (gram staining), cyanides (hematology) and formaldehyde and xylene (pathology) and other reagents, wastewater from autoclaves. Laboratories may also contribute to the presence of blood in wastewater from the emptying of samples into the sinks.
<b>Radiology</b>	Photochemical (developing and fixing solutions) containing wastewater and potentially contaminated rinsing water, fixers and developers. Developing solutions can contain formaldehyde, which is a known human carcinogen.
<b>Renal Department</b>	Body fluids from machines, disinfectants, dialyzer solutions, wastewater from reverse Hemodialysis osmosis process.

HCF Department	Waste Source and Characteristics
<b>Central Sterilization Room</b>	Disinfection solution, including aldehyde-based disinfectants. Hot water from the sterilizers and detergents from the CD Machine (Cleaning and Disinfection), Wastewater from autoclaves and sterilizing equipment.

Source: *Health-care Waste Management Manual, 3rd Edition (DOH, 2011)*

## 6.4 Collection of HCF Wastewater

Segregation, minimization, and safe storage of hazardous materials are just as important for liquid wastes as they are for solid wastes. Wastewater management must also be implemented by the HCF. The basic principle of effective wastewater management is a strict limit on the discharge of hazardous liquids to sewers.

Wastewater generated in the HCF is collected by sewer pipes, going to the wastewater treatment facility of the HCF or to the municipal sewer to be transported in a treatment facility together with the wastewater from the community. The preferred set-up is to construct separate sewerage systems for wastewater and stormwater (referred to as sanitary sewers and storm sewers). Combined sewerage systems that transport liquid waste discharges and stormwater together to a common treatment facility are no longer recommended. Stormwater or rainwater can be collected separately and used for gardens or other purposes that do not need highly processed water, such as toilet flushing, washing vehicles, or cleaning outdoor paved areas. Furthermore, the separate collection of greywater and blackwater is normally not recommended, because it can cause hydraulic problems (blockages) due to low flow volumes in the collection of the blackwater.

Chemical waste especially photochemical, aldehydes (formaldehyde and glutaraldehyde), colorants, and pharmaceuticals—should not be discharged into wastewater but should be collected separately and treated as a chemical HCW.

Radioactive wastewater from radiotherapy (e.g., urine of patients undergoing thyroid treatment) should be collected separately and stored in a secured place until the levels of radioactivity have decreased to background concentrations. After the required storage time, the wastewater can be disposed of into a sewer. A separate toilet facility must be provided to the patients that are given high doses of radioactive isotopes for therapy.

Larger quantities of blood may be discharged in the sewers if a risk assessment shows that the likely organic loading in the wastewater does not require pre-treatment. Otherwise, blood should be first disinfected, preferably by a thermal method, or disposed of as pathological waste. Blood can also be disposed of directly to a septic tank system if safety measures are followed.

## 6.5 Treatment of HCF Wastewater

The HCF may provide its own wastewater treatment facility or may connect to a municipal or centralized wastewater

treatment facility for the treatment of wastewater.

### **6.5.1 Connection to a Municipal/Centralized Wastewater Treatment Plant**

If the HCF is located in a city or town with a central or municipal sewerage system, it may be suggested, according to the local regulation, to discharge the HCF wastewater to the sewer. If the HCF is connected to a municipal sewer system, the HCF may need to provide a pre-treatment to the wastewater before discharging it to the municipal sewer. The pre-treatment system depends on the quality of the wastewater to be pre-treated and the required quality of the wastewater that can be discharged to the municipal sewer.

#### **The minimum requirements for discharging to the municipal or centralized sewer system are:**

- The sewers should be connected to an efficient wastewater treatment plant with primary, secondary, and tertiary treatment;
- A central treatment plant ensures at least a 95% removal of bacteria;
- The sludge resulting from sewage treatment should be subjected to further treatment, such as anaerobic digestion, leaving no more than one helminth egg per liter in the digested sludge; and
- The waste management system of the HCF maintains high standards, ensuring only low quantities of toxic chemicals, pharmaceuticals, radionuclides, cytotoxic drugs, and antibiotics in the discharged

sewage.

### **6.5.2 Pre-treatment of HCF wastewater**

Pre-treatment is recommended for wastewater streams from departments such as medical laboratories. This pre-treatment could include acid-base neutralization, filtering to remove sediments or autoclaving samples from highly infectious patients.

- Non-hazardous chemicals such as syrups, vitamins or eye drops can be discharged to the sewer without pre-treatment.
- A grease trap can be installed to remove grease, oil, and other floating materials from kitchen wastewater. The trap and collected grease should be removed every 2–4 weeks.
- Collected body fluids, small quantities of blood and rinsing liquids from theatres and intensive care can be discharged in the sewer without pre-treatment. Precautions against blood spatter should always be taken (e.g., wearing PPE and following standardized handling procedures), and care should be taken to avoid blood coagulation that could block pipes. Expired blood bags shall not be emptied into a sink because of the risk of infection from blood splatters.

#### **The following points have to be considered in implementing pre-treatment:**

- The 5% sodium hypochlorite (NaOCl – bleach) is not effective for disinfecting liquids with a high organic content such as blood and stools. Sodium hypochlorite should never be mixed with detergents or used for disinfecting ammonia-



containing liquids because it might form toxic gases.

- Chlorine-based disinfectants (such as sodium hypochlorite) shall not be disposed of in a septic tank, as it will harm the bacteria used for the biological treatment process.
- Lime milk (calcium oxide) can be used to destroy microorganisms in liquid wastes with high organic content requiring disinfection (e.g., stool or vomit during a cholera outbreak). In these cases, faeces, and vomit should be mixed with the lime milk in a ratio of 1:2, with a minimum contact time of six hours. Urine can be mixed 1:1, with a minimum contact time of two hours.
- Wastewater from the dental department should be pre-treated by installing an amalgam separator in sinks, particularly those next to patient treatment chairs. Mercury waste must be safely stored.

### 6.5.3 On-site Wastewater Treatment Plant (WWTP)

Larger HCFs, particularly those that are not connected to any municipal treatment plant, should operate their own wastewater treatment plant. This could include physical, chemical, and biological processes to remove contaminants from the raw sewage.

Typically, wastewater treatment involves three stages; primary, secondary and tertiary. The first stage is the removal of solids that are separated by sedimentation (primary treatment). Second, dissolved biological matter is progressively converted into a solid mass using indigenous waterborne

bacteria. Some inorganic components will be eliminated by sorption to sludge particles, which are then separated from the liquid phase of the wastewater by sedimentation (secondary treatment). During the third stage (at the end of the treatment process), after the solid and liquid materials are separated, the treated water may be further treated to remove suspended solids, phosphates, or other chemical contaminants, or maybe disinfected (tertiary treatment).

## 6.6 Disposal of treated effluent

The treated effluent of the on-site wastewater treatment plant must comply with the general effluent standards before discharge. The treated effluent should be disinfected with an appropriate disinfectant prior to discharge to the environment. Chlorine-based disinfectants are traditionally used to disinfect health-care wastewater (tertiary treatment). The effectiveness of disinfection depends heavily on the quality of the water being treated (e.g. turbidity, pH), the type of disinfectant being used and the disinfectant dosage (concentration and time). Short contact times, low doses, high organic contents and high flows all reduce effective disinfection.

Common methods and agents for disinfection include NaOCl (a commonly used disinfectant in healthcare facilities) and chlorine dioxide (ClO<sub>2</sub>). Chlorine dioxide can be considered more efficient than NaOCl. Ultraviolet (UV) light is replacing chlorine due to the concerns about the impacts of chlorine; however, UV lamps need frequent maintenance and replacement, as well as a highly treated effluent. Ozone (O<sub>3</sub>) is another option that can oxidize most organic material it comes in contact with but requires highly

skilled operators, and investment costs are comparatively high. However, ozone has advantages: it is a more effective disinfectant than chlorine, its action is less susceptible to changes in pH, and it can destroy specific chemical contaminants (such as some pharmaceuticals) in the wastewater.

## 6.7 Disposal of sludge

The treatment process of the wastewater will generate sludge or biosolids that contains high concentrations of helminths and other pathogens and should be treated before disposal. The most common treatment options include anaerobic digestion, aerobic digestion, and composting. Composting or sludge de-watering and mineralization beds are most commonly used for on-site treatment in hospitals.

For composting, sludge is mixed with a carbon source such as sawdust, straw, or wood chips. In the presence of oxygen, bacteria digest the sludge and the carbon source and create heat that will pasteurize the sludge. In dewatering and mineralization beds, sludge is applied on a horizontal system – flow reed bed. One part of the water is absorbed by the reeds, which then transpire moisture into the air; the other part is returned to the wastewater treatment plant through a drainage layer in the bottom of the reed bed. The de-watered sludge is incorporated into the microbiologically active top layers of the root zone of the reeds, where it is mineralized and turned into soil.

## 6.8 Basic Wastewater Treatment System for Rural HCF: Minimum requirement for HCFs in Ethiopia

For HCFs, especially primary care facilities and HCFs located in the rural areas, that do

not have an on-site wastewater treatment plant or a sewerage system in their area may opt to provide a basic wastewater treatment system. This system consists of a primary and secondary treatment stage, which is considered as the minimum treatment for primary- and secondary- level rural hospitals. These are the minimum requirement for HCFs in Ethiopia to be implemented by all if they did not have the technical and financial feasibility to have conventional wastewater treatment plants.

Note that sludge and sewage from HCF generated by a basic wastewater management system should never be used for agricultural or aquaculture purposes. Effluents from the basic treatment should not be discharged into water bodies that are used nearby to irrigate fruit or vegetable crops or to produce drinking water or for recreational purposes.

Basic systems can reduce the risk of waterborne diseases drastically if appropriately planned and implemented; more advanced systems reduce the risk further. Pharmaceuticals and other hazardous liquid wastes in wastewater may form a serious future problem and must be carefully observed and minimized. This includes reducing to an absolute minimum the presence of antibiotics and pharmaceutical residues in wastewater.

Three basic wastewater management systems, which can be used by the HCFs:

1. septic tank system;
2. centralized basic system; and
3. lagoon system.

The effluent from a septic tank and centralized basic systems can be further treated but if not possible, a controlled

discharge to soak away pits or leach fields should be carried out. However, soak away pits and leach fields present a threat of contamination to nearby wells. Both should be kept as far as practicable from shallow water wells and, where possible, they should be installed downstream of water abstraction sources. The distance between the bottom of the infiltration system and the groundwater table should be at least 1.5 meters (more in coarse sands, gravels, and fissured geological formations), and the system should be at least 30 meters from any groundwater source.

### 6.8.1 Septic tank system

The minimum treatment method for wastewater is the septic tank, a watertight receptacle for the separation of solid and liquid components of wastewater and the digestion of organic matter in an anaerobic environment. A septic tank also takes on the functions of storing solids and allowing clarified liquid to outflow for further treatment or discharge. HCFs in Ethiopia at least should have a properly designed and constructed septic tank as a minimum requirement.

A septic tank normally consists of two or

more chambers and can be divided into the following zones;

1. horizontal: inflow, settlement and clarifying zone; and
2. vertical: scum, detention, and sludge zone.

The capacity of the septic tank should be equivalent to a total of two days' wastewater flow. If a two-chamber system is used, the first chamber should be two-thirds of the total capacity. The effective settling and floating of solids are directly dependent upon the retention time within the tank, which should be not less than 24 hours. Anaerobic bacteria partly break down this solid matter.

Note that excessive build-up of sludge and scum reduces the capacity of the detention zone, resulting in the discharge of suspended solids to the effluent disposal system. If the level of solid matter cannot be controlled, it should ideally be removed once every two years. A simplified sketch of a sample two-chambered septic tank is presented in Figure 6.1.

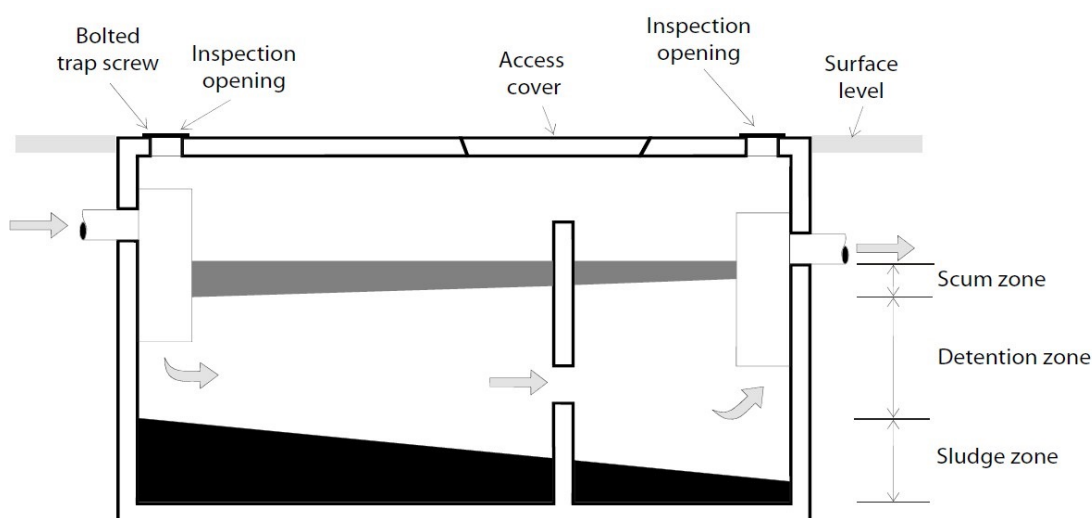

**Figure 6. 1: A sketch of sample two-chambered septic tank (WHO, 2014)**

**The standard criteria for septic tank systems operation and maintenance consist of the following:**

- Septic tank must be desludged every four (4) years to maintain its designed treatment efficiency.
- Keep a record of pumping, inspections, maintenance, and repairs.
- Inspect the tank for cracks, and check that baffles or tees are in place. Check for ponding of water near the treatment and disposal system.
- Refrain from using septic starters, additives, or feeders (i.e., enzymes).
- Practice water conservation to prevent overloading the septic tank system. Check for defective toilet tank valves, repair leaky fixtures, and install appliances and fixtures that use less water and avoid wasteful practices.
- Divert excess rainwater runoff away from the septic tank and leaching field system.
- Keep trees and deep-rooted plants and shrubs away from the immediate area that may intrude or clog the system.
- Do not park or drive heavy vehicles or equipment over the septic system or any of its components.

### **6.8.2 Centralized basic system**

Basic centralized systems consist of primary treatment (sand catchment and screen to remove large particles) and an anaerobic secondary treatment system. This is recommended for HCF to minimize maintenance, allow advanced treatment, and improve the monitoring of the wastewater system. Typical secondary treatment systems include baffled flow reactors; anaerobic filters; Imhoff tank; and up-flow anaerobic sludge blanket reactor. Most of the systems allow for the harvesting of methane biogas if facilities are available. The effluents can be further treated. If this is not possible, a controlled discharge to soak away pits or leach field should be carried out.

#### **A. Soak away Pits**

A soak away pit should have one or more tanks, with the total volume equal to the wastewater treatment plant. Effluents from the treatment plant are collected and allowed to infiltrate into the ground. The pit may be filled with stones, broken bricks or similar material or maybe lined with open-jointed masonry. The top 0.5 meters of the pit should be lined solidly, to provide firm support for a reinforced concrete cover. Planting trees adjacent to or over a soak away can improve liquid removal through transpiration and increased soil permeability.

#### **B. Leach fields**

When larger amounts of wastewater need to be infiltrated (e.g., district hospitals), a leach field is often a better solution. Leach fields consist of gravel-filled underground trenches, called leach lines, which allow the liquid effluent from the wastewater treatment to permeate into the ground. A leach field may

be characterized by open-jointed (stoneware) or perforated (polyvinyl chloride) pipes that carry the liquid effluent into the leach field; trenches that are usually 0.3–0.5 meter wide and 0.6–1.0 meter deep (from the top of the pipes) and laid with a 0.2–0.3% gradient of gravel (20–50mm diameter), covered by a 0.3–0.5 meter layer of soil.

### C. Lagoon system

In an individual HCF that cannot afford sophisticated sewage-treatment plants, and where infiltration of the wastewater is not possible, a lagoon system is a basic solution for treating wastewater, if enough land is available. There are two lagoon systems that can be considered; aerated lagoon and facultative lagoon.

#### Aerated Lagoons

Oxygen is supplied by mechanical surface aeration thus requires comparatively high operational costs due to electricity.

#### Facultative Lagoons

Oxygen is supplied primarily by algae. Facultative means the presence of an anaerobic bottom region below an aerobic top layer. Facultative lagoons consist of a shallow basin in which settleable solids carried by the wastewater fall to the bottom and form a sludge layer that decomposes anaerobically. Facultative lagoons can have the disadvantages of potentially generating pungent odors, variable effluent quality, and a need for a large land surface area.

#### Guide to a basic wastewater system

- Enforce liquid hazardous waste management; segregate and pre-treat hazardous waste.
- Set up a maintenance system for the sewers and the septic tanks, provide maintenance equipment and clean septic tanks regularly.
- Set up a budget line to cover wastewater-treatment costs.
- Ensure that chemical disinfection is only used when the suspended organic matter in wastewater is >10 mg/L.
- Replace any broken or non-watertight septic tanks and install sewer pipes with watertight joints.
- Install grease traps for the kitchen wastewater and clean regularly.
- Regularly inspect the sewerage system and repair it whenever necessary.
- Introduce tertiary treatment systems such as sand filtration or a subsurface horizontal gravel filter overplanted with vegetation to increase transpiration.
- Disinfect the wastewater by UV or change to chlorine dioxide or ozone (a combination of UV and ozone is most effective).
- Neutralize wastewater from laboratories before discharge into the sewerage system.
- Set up an “antibiotic committee” to minimize the usage of antibiotics within the HCF.

# 7 Occupational health and safety practices in HCWM

HCWM policies, plans, and programs shall include provisions for the health and safety of HCF workers. Educating the HCF workers on the risks associated with HCW shall be part of this policy. Established policies and procedures ensuring the health and safety of HCF workers from generation, segregation, storage to the collection, transport, treatment, and disposal of HCW shall be consistently implemented and complied with by all concerned. However, the occupational safety of health-care personnel and workers handling waste is often overlooked. The purpose of this section is to explain the hazards and infection risks they may encounter, and the prevention and control of exposure to them. HCWM policies or plans should include arrangements for the continuous monitoring of workers' health and safety.

## 7.1 Principles

### **Sensible occupational health and safety measures include the following:**

- Develop a standardized set of management rules and operating procedures for HCW, when respected by personnel and monitored by the HCF management, can dramatically reduce the risk of accidents. HCF staff should be taught and kept informed about the HCWM system and procedures in place.
- Inform and train waste workers so that they perform their duties properly and safely. Training in health and safety is intended to ensure that workers know of and understand the potential risks associated with HCW, and the rules and procedures they are required to respect for its safe management.
- Involve waste workers in hazard identification and recommendations for prevention and control. Workers at risk from infection and injury include health-care providers, cleaners/maintenance staff, treatment equipment operators, and all personnel involved in waste handling and disposal within and outside HCFs.
- Provide equipment and clothing for personal protection. They should be informed on the importance of consistent use of PPE and should be aware of where to obtain post-exposure follow-up in case of a needle-stick injury or other blood exposure.
- Establish an occupational health program that includes information, training, and medical measures when necessary, such as immunization, post-exposure prophylactic treatment and regular medical surveillance. Health-care personnel should be trained for emergency response if injured by a waste item, and the necessary equipment should always be readily available. Written procedures for the different types of emergencies should be drawn up.

- To limit the risks, the hospital management must set up management rules and operating procedures for HCW and establish standardized emergency procedures. It is the responsibility of everybody involved in handling waste to know the emergency procedures and to act accordingly.

## 7.2 Occupational Health Risks

### 7.2.1 Cytotoxic Safety

In hospitals that use cytotoxic products, specific guidelines on their safe handling should be established for the protection of personnel. These guidelines should include rules on the following waste handling procedures:

- Separate collection of waste in leak-proof bags or containers and labeling for identification;
- Return of outdated drugs to suppliers;

Safe separate storage of genotoxic waste away from other HCW;

- Arrangements for the disposal of contaminated material, the decontamination of reusable equipment and the clean-up of spillages; and
- Arrangements for the treatment of infectious waste contaminated with cytotoxic products, including excreta from patients, disposable linen, and absorbent material for incontinent patients.

### **The following measures are important to minimize exposure:**

- Written procedures that specify safe working methods for each process;
- Datasheets, based on the suppliers' specifications, to provide information on potential hazards and their minimization;
- Established procedure for emergency response in case of spillage or other occupational accident; and
- Appropriate education and training for all personnel involved in handling cytotoxic drugs.

Hospital staff should ensure that the families of patients undergoing chemotherapy at home are aware of the risks and know how they can be minimized or avoided. The senior pharmacist at the HCF should be made responsible for ensuring the safe use of cytotoxic drugs. Large oncological hospitals may appoint a full-time genotoxic safety officer, who should also supervise the safe management of cytotoxic waste.

### 7.2.2 Other Health Hazards

Actual cases of non-sharps waste being demonstrated to cause an infection in health-care personnel and waste workers are rarely documented. HCW handlers are at greatest risk from infectious hazards, which include chemical exposures such as chemotherapeutic drugs, disinfectants, and sterilants; physical hazards such as ionizing

radiation; and ergonomic hazards. The risk of acquiring a secondary infection following needle-stick injury from a contaminated sharp depends on the amount of the contamination and the nature of the infection from the source patient. The risk of infection with hepatitis B is more than 10 times greater than for hepatitis C and up to 100 times greater than for HIV.

**Table 7. 1: Summary of hazards and health effects of HCW to health-care workers and their control measures**

<b>Hazards</b>	<b>Health Effects</b>	<b>Control Measures</b>
<b>Sharps injuries and resulting exposure to blood-borne pathogens</b>	Infections with hepatitis B or C, HIV, malaria or other blood- borne infections	Immunization against Hepatitis B virus Appropriate disposal of sharps at the site of use into a puncture-resistant container without recapping; Use of engineered needles that automatically retract, blunt re-sheath, or disable the sharp
<b>Other biological hazards</b>	SARS, COVID 19, Tuberculosis, Influenza	Exhaust ventilation (natural or mechanical), masking
<b>Chemicals Chlorine disinfectants (Sodium hypochlorite)</b>	Skin and respiratory sensitization Eye and skin irritation, weakness, exhaustion, drowsiness, dizziness, numbness and nausea	Substitute soap and water for cleaning chemicals Avoid soaking sharps in chlorine when they will receive autoclaving or incineration before disposal Dilute chemicals appropriately according to the manufacturer for less toxic exposure
<b>High-level disinfectant glutaraldehyde</b>	Irritation of the eyes, nose and throat Skin sensitization Occupational asthma where the symptoms in affected individuals include chest tightness and difficulty in breathing	Substitute steam sterilization except for pressure-sensitive instruments Ensure appropriate dilution and use in a closed, ventilated system
<b>Sterilants: ethyleneoxide</b>	Eye and skin irritation, difficulty breathing, nausea, vomiting, and neurological problems such as headache and dizziness. Reproductive hazard, linked to nerve and genetic damage, spontaneous abortion and muscle weakness Carcinogen	Substitute steam sterilization for ethylene oxide except for pressure- sensitive instruments Use only in a closed and ventilated system



Hazards	Health Effects	Control Measures
<b>Heavy lifting Handling heavy loads over long periods</b>	Back injuries and musculoskeletal disorders Degenerative diseases of the lumbar spine	Reduce the mass of objects or number of loads carried per day Use waste carts with wheels, automated waste transfer from cart to truck and treatment Use lifts and pulleys to assist in transferring loads
<b>Ionizing radiation</b>	Irreversible damage of cells, anemia, leukemia, lung cancer from inhalation	Safe waste management, in full compliance with all relevant regulations, must be considered and planned for at the early stages of any projects involving radioactive materials. It should be established from the outset that the waste can be properly handled, treated and ultimately disposed of. <i>See International Atomic Energy Agency for national regulatory standards and safety guidance</i>

Source: *Safe Management of Wastes from Health-Care Activities, 2nd Edition (WHO, 2014)*

## 7.3 Exposure Prevention and Control

A proper and safe segregation system for hazardous waste is the key to occupational safety and environmentally sound handling of HCW. Implementing a proper segregation system must be accompanied by safe and standardized handling procedures.

### 7.3.1 Hierarchy of Controls for Blood-borne Pathogens

Methods to control occupational hazards have traditionally been discussed in terms of hierarchy and presented in order of priority for their effectiveness in preventing exposure to the hazard or preventing injury resulting from exposure to the hazard. Controlling exposures to occupational hazards is the fundamental method of protecting workers. Hierarchy of controls has been used as a means of determining feasible and effective

controls. One representation of this hierarchy can be summarized as follows.

#### A. Elimination and Substitution

Complete removal of a hazard from the work area. Elimination is the preferred method in controlling hazards, and whenever possible it should be the first choice. While it is the most effective at reducing hazards, also tends to be the most difficult to implement in an existing process. If the process is still at the design or development stage, elimination of hazards and substitution of control may be inexpensive and simple to implement.

On the existing process, major changes in equipment and procedures may be required to eliminate hazards or substitute control. Examples include removing sharps and needles and eliminating all unnecessary injections. Jet injectors may substitute

for syringes and needles. All unnecessary sharps, such as towel clips, should also be eliminated, and needleless systems should be used.

## **B. Engineering Control**

Engineering control is used to remove a hazard or place a barrier between the worker and the hazard. Engineering controls to reduce or eliminate hazard include the following.

This includes designing the facility, equipment and processes to eliminate or minimize the hazards. It also includes substituting the processes, equipment, devices, materials or other factors to lessen the hazards, and isolating the hazard by enclosing the source or putting barriers between the source of hazard and the exposed workers; using interlocks, machine guards, blast sheets, protective curtains and/or other means. Moreover, removing or redirecting the hazard using local exhaust ventilation, and adopting complete mechanization or computerization are examples of engineering control.

Well-designed engineering controls can be highly effective in protecting workers and are typically independent of worker interactions. The initial cost of engineering controls can be higher than the cost of administrative controls or PPE, but over the long term, operating costs are frequently lower, and in some instances, can provide cost savings in other areas of the process.

## **C. Administrative Control**

Administrative controls are policies to limit exposure to a hazard (e.g., universal precautions). Includes assessment of risks, medical controls including the provision of PPEs, establishment of waste management

policies, procedures, guidelines, and activities, the conduct of regular and effective training, management of human resources and procurement of appropriate equipment and supplies. Administrative controls and PPE are frequently used with existing processes where hazards are not particularly well controlled. While relatively inexpensive to establish, it can be very costly to sustain over the long term.

Examples include allocation of resources demonstrating a commitment to staff safety, an infection-control committee, an exposure control plan, replacement of all unsafe devices and consistent training on the use of safety devices. These methods for protecting workers have also proven to be less effective than other measures, requiring significant effort by the affected workers.

### **Medical control includes written policies with standard operating procedures on the following:**

- Patient Safety which includes proper patient identification, assurance of blood safety, safe clinical and surgical procedures, provision and maintenance of safe quality drugs and technology, strengthening of infection control, maintenance of environment care standards and energy/waste management standards.
- Occupational Health and Safety which includes physical examination (pre-employment and annual), regular immunization, health education and wellness, and continuous medical monitoring and periodic evaluation of safety measures.

## D. Work Practice Controls

These controls reduce exposure to occupational hazards through the behavior of workers. Examples include no needle recapping, placing sharps containers at eye level and arm's reach, emptying sharps containers before they are full, and arranging for the safe handling and disposal of sharps devices before beginning a procedure.

## E. Personal Protective Equipment (PPE)

This refers to specialized clothing or equipment worn by a worker designed to protect against infectious materials or from exposure to infectious agents thus, preventing injury or illness from a specific hazard. Adequate and appropriate PPE shall be provided to HCF workers who are exposed to hazardous waste. This includes protection for the whole body – head, face, body, arms, legs, and feet.

The most effective PPE in reducing the risk of injury are gloves to protect from exposure to blood, other potentially infectious materials, and chemicals; particulate masks (respirators) to protect from respiratory infections hazards and particulates from burning waste, and boots for waste handlers to protect from sharps injuries to the foot. Availability and access to soap and water, and alcohol hand rub, for hand hygiene, are also important to maintain cleanliness and inhibit the transfer of infection via dirty hands.

### Required PPEs for health-care workers

The type of protective clothing used will depend to an extent upon the risk associated with the HCW, but the following should be made available to all personnel who collect or handle the waste. Table 7.2 shows examples of PPEs for HCW handlers in HCFs.

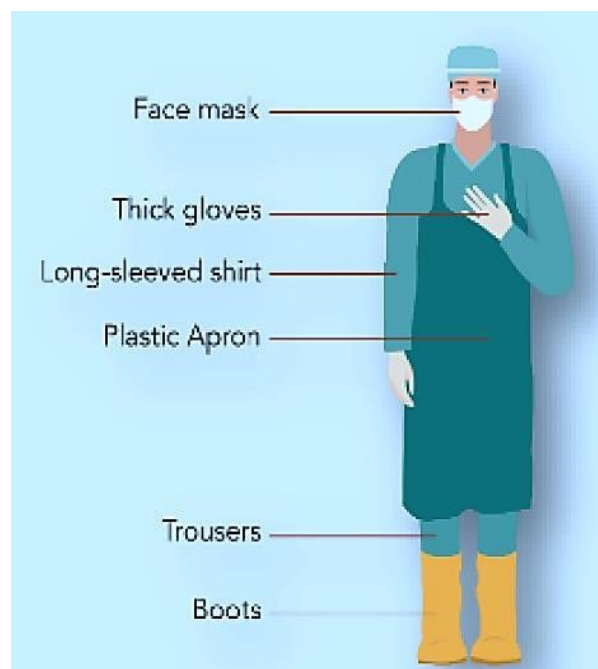

### Obligatory

- *disposable gloves (medical staff) or heavy-duty gloves (waste workers)*
- *industrial aprons*
- *overalls (coveralls)*
- *leg protectors and/or industrial boots*



### Depending on the type of operation



- *eye protectors (safety goggles)*
- *face masks (if there is a risk of splash into eyes)*
- *helmets, with or without visors.*

Industrial boots and heavy-duty gloves are particularly important for waste workers. The thick soles of the boots offer protection in the storage area as a precaution from the spill, sharps, and slippery floors. If segregation is inadequate, needles or other sharps items may have been placed in plastic bags; such items may also pierce thin-walled or weak plastic containers. If it is likely that HCW bags will come into contact with workers' legs during handling, leg protectors may also need to be worn.

Source: *Safe Management of Wastes from Health-Care Activities, 2nd Edition (WHO, 2014)*

Table 7. 2: Sample PPEs and their specifications for HCW handlers

Equipment	Specifications	Example
<b>Industrial Apron</b>	Durable, reusable design that is able to withstand periodic disinfectant Water-resistant	
<b>Coverall</b>	The material surface can resist inorganic and organic liquids from going within. The coveralls are highly resistant to rubbing off or tearing. It is completely capable of keeping the protective properties intact. Coveralls have high visibility marks in arms, neck, and legs. It helps increase the visibility of the worker during the day and night.	
<b>Heavy-duty Gloves</b>	Durable, reusable design that is able to withstand periodic disinfectant. Available in sizes appropriate for workers in the facility Able to prevent blood-borne pathogens contained in health-care waste. Made from puncture-resistant materials to protect against needle sticks and cuts from other sharps Maximum palm thickness is 0.5/20 mil Straight cuff for maximum protection from contaminated liquids. Cuff should reach at least 75 mm from the upper arm surface when the elbow is flexed at 90°	

Equipment	Specifications	Example
<b>Boots</b>	<p>Made from cut-resistant materials</p> <p>Slip-resistant sole (deep tread with the coefficient of friction &gt;0.5)</p> <p>Puncture-resistant sole (minimum protection of 1200 Newton)</p> <p>Protective from minimal impact (toe impact energy up to 90 joules)</p> <p>Fit snugly and not unduly interfere with the movements of the wearer</p> <p>Durable</p> <p>Capable of being disinfected</p> <p>Available in sizes to fit all waste handlers (toe should be about 12.5 mm from the front)</p>	
<b>Eye protection gear</b>	<p>Provide adequate protection against the particular hazards for which they are designed</p> <p>Reasonably comfortable when worn under the designed conditions</p> <p>Fit snugly and do not unduly interfere with the movements of the wearer</p> <p>Durable</p> <p>Capable of being disinfected</p> <p>Able to wear without disturbing the adjustment of any existing prescriptive eyewear</p> <p>Made of Polycarbonate</p> <p>The lens should be impact and heat resistant with anti- fog coating</p> <p>Designed for unobstructed peripheral vision</p> <p>Adjustable support strap</p>	

Source: fhi360, Health-care Waste Management Worker PPE – Guidance

HCF workers should know the correct usage and maintenance of the equipment. PPE shall conform to established standards.

**Training on PPE shall include:**

- Description of the type of hazard and the condition of the work environment – determination of waste management concerns, working conditions, materials, equipment, and substances used, the exposed populations and conditions of exposure, taking into account the adverse effects on human health and to the environment.
- Explanation on why a certain type of PPE has been selected – based on the hazards present, the type of materials used and how they will be handled.
- Explanation on its proper use, maintenance, and storage – PPE shall be kept safe and in good condition.
- Defective PPE shall be discarded. Since PPEs have limitations and useful life, these must be regularly inspected for their effectiveness.

### 7.3.2 HCF Hygiene and Infection Control

Management of HCW is an integral part of HCFs hygiene and infection control. HCW can be considered as a reservoir of pathogenic microorganisms, which – if someone is exposed – could give rise to an avoidable infection. If waste is inadequately managed, these microorganisms can be transmitted by direct contact, by inhalation or by a variety of animal vectors (e.g., flies, rodents, roaches), which could be exposed to waste.

A basic infection-control principle is to know the chain of infection and identify the most effective points to prevent potential disease transmission. Transmission of infectious diseases in an HCF requires at least six elements: an infectious agent, a reservoir, a portal of exit, a means of transmission, a portal of entry, and a susceptible host.

## 7.4 Prevention of Nosocomial Infection

Two basic principles govern the main control measures to prevent the spread of nosocomial infections in HCFs:

1. Separate an identified source of infection from other patients and medical areas; and
2. Eliminate all obvious routes of transmission.

The separation of the source has to be interpreted in a broad sense. It includes the isolation of infected patients and implements aseptic conditions by introducing measures intended to act as a barrier between infected or potentially contaminated tissue and the environment, including other patients and medical staff.

### 7.4.1 Standard Precautions

These should be taken with every patient, independent of any known condition (e.g., infected or colonized), to protect health-care workers from exposure to infectious disease. It is impossible to avoid all contact with infected tissue or potentially contaminated body fluids, excreta, and secretions. Even when they are not touched with the bare hands, they may come in contact with instruments, containers, linen or similar items.

## 7.4.2 Isolation

The first measure in preventing the spread of nosocomial infections is the isolation of infected patients. Maintaining isolation is expensive, labor-intensive, and usually inconvenient for both patients and health-care personnel. Its implementation should be adapted to the severity of the disease and the causative agent.

## 7.4.3 Cleaning

Cleaning is one of the most basic measures for maintaining hygiene in the health-care environment. It is essentially a mechanical process whereby the dirt is dislodged from a surface; suspended or dissolved in a water film and diluted until it is no longer visible, and rinsed off. Soaps and detergents act as solubility-promoting agents. Cleaning should be carried out in a standardized manner and preferably by automated means that will guarantee an adequate level of cleanliness. Diluting and removing the dirt also removes the breeding ground or culture medium for bacteria and fungi. Most non-sporulating bacteria and viruses survive only when they are protected by dirt or a film of organic matter; otherwise, they dry out and die.

## 7.4.4 Sterilization and disinfection

The effectiveness of disinfection and sterilization is increased by prior or simultaneous cleaning. Self-evidently, an object should be sterile (i.e., free of microorganisms) after sterilization. However, sterilization is never absolute; by definition, it reduces the number of microorganisms by a factor of more than  $10^6$  (i.e., more than 99.9999% of microorganisms are killed). The term “disinfection”

is difficult to define because the activity of a disinfectant process can vary widely.

### **The guidelines for environmental infection control in HCFs allow the following distinctions to be made:**

- High-Level Disinfection: can be expected to destroy all microorganisms, except for large numbers of bacterial spores;
- Intermediate Disinfection: inactivates *Mycobacterium tuberculosis*, vegetative bacteria, most viruses, and most fungi; does not necessarily kill bacterial spores;
- Low-Level Disinfection: can kill most bacteria, some viruses, and some fungi; cannot be relied on to kill resistant microorganisms such as tubercle bacilli or bacterial spores.

*Source: CDC, 2003*

There is no ideal disinfectant, and the best compromise should be chosen according to the situation. A disinfectant solution is considered appropriate when the compromise between the antimicrobial activity and the toxicity of the product is satisfactory for the given application. The principal requirements for a good antiseptic are absence of toxicity, rapid action, and adequate activity on natural flora and pathogenic bacteria and other microorganisms after a very short exposure time. Essential requirements for a disinfectant are somewhat different. There must be adequate activity against bacteria, fungi and viruses that may be present in large numbers and protected by dirt or organic matter. Besides, since disinfectants are applied in large quantities, they should

be of low eco-toxicity. In general, the use of the chosen disinfectant, at the appropriate concentration and for the appropriate time, should kill pathogenic microorganisms, rendering an object safe for use in a patient, or rendering human tissue free of pathogens to exclude cross-contamination.

## 7.5 Occupational Health and Safety Program

### 7.5.1 Immunization

#### A. Pre-employment immunization

HCF workers shall be given immunization to prevent or ameliorate the effects of infection by many pathogens such as viruses causing hepatitis B and tetanus infection. Many HCF workers are at risk of exposure to and possible transmission of vaccine-preventable diseases because of their contact with infectious materials in the HCW. Maintenance of immunity is therefore an essential part of the prevention and infection control programs for HCF workers.

#### B. Post-exposure prophylaxis

Post-exposure prophylaxis (PEP) is short-term antiretroviral treatment (for HIV) or immunization (for hepatitis B) to reduce the likelihood of infection after potential exposure. Within the health sector, PEP should be provided as part of a comprehensive universal precautions package that reduces staff exposure to infectious hazards at work. PEP for HIV comprises a set of services to prevent the development of the infection in the exposed person. These include first-aid care; counselling and risk assessment; HIV blood testing; and, depending on the risk assessment, the provision of short-term (28 days) antiretroviral drugs, with follow-up and support. Most incidents

linked to occupational exposure to blood-borne pathogens occur in HCFs.

The WHO and the International Labor Organization have published guidelines on PEP to prevent HIV infection.

#### **A summary of PEP recommendations from these guidelines are as follows:**

- PEP should be provided as part of a package of prevention measures that reduce staff exposure to infectious hazards.
- PEP should be available to health-care workers and patients.
- Occupational PEP should also be available to all workers who could be exposed while performing their duties (such as social workers, law enforcement personnel, rescue workers, refuse collectors).
- Countries should include occupational PEP in national health-care plans.

### 7.5.2 Hand Hygiene

The hands of healthcare workers are the most frequent transmission route for nosocomial infections. Hand hygiene, both handwashing and hand disinfection should be seen as the primary preventive measure that is the responsibility of all health-care personnel. Provision for washing facilities (with soap and warm water) and instruction shall be made available at the point needed to ensure that proper handwashing is observed.

Thorough handwashing with adequate quantities of water and soap removes more than 90% of the transient (i.e., superficial) flora, including all or most contaminants. An



antimicrobial soap will further reduce the transient flora, but only if used for several minutes. Handwashing with (non- medicated) soap is essential when hands are dirty and should be routine after every physical contact with a patient.

Killing all transient flora within a short time (a few seconds) necessitates hygienic hand disinfection: only alcohol or alcoholic preparations act sufficiently fast. Hands should be disinfected with alcohol when an infected tissue or body fluid is touched without gloves.

**The WHO guidelines for hand hygiene in healthcare includes the following guidance for hand washing and use of alcohol-based hand rubs:**

- If hands are not visibly soiled, use an alcohol-based hand rub for routine antisepsis (hygienic hand disinfection). Rub until hands are dry.
- Wash hands before starting work, before entering an operating theatre, before eating, after using a toilet, and in all cases where hands are visibly soiled.
- Keep nails short and clean.
- Do not wear artificial fingernails, nail polish or jewelry.
- Do not wash gloves between uses with different patients.
- Multiple-use cloth towels of the hanging or roll type are not recommended for health-care establishments.
- When bar soap is used, soap racks that facilitate drainage and only small bars should be used; liquid

detergents in dispensers are preferred.

- To prevent contamination, do not add soap to a partially empty liquid-soap dispenser. Empty the dispenser completely and clean it thoroughly before refilling.
- Hand hygiene products should have low skin irritation, particularly in multiple-use areas, such as intensive care or operating rooms.
- Ask personnel for their views regarding the tolerance of any products under consideration.
- For surgical scrub, preferably use an alcohol-based hand rub.
- When using an alcohol-based surgical hand rub, pre-wash with soap, and dry hands and forearms completely (including removal of debris from underneath the nails using a nail cleaner) once a day before starting surgery and when hands become soiled (e.g., glove perforation) or sweaty. Brushes are not necessary and can be a source of contamination. Hand washing, immediately before every rub, does not improve its efficacy and should be abandoned. Rub for 1–5 minutes according to the manufacturer’s recommendation after application and rub until hands are dry before donning sterile gloves.
- Hands must be fully dry before touching the patient or the patient’s environment/equipment for the alcohol hand rub to be effective. This will also eliminate the extremely rare risk of flammability.

- Use hand lotions frequently to minimize the possibility of irritant contact dermatitis.

Standard precaution and proper hand hygiene procedure are in detail shown in Annex-3, 4 and 5, and the five moments of hand hygiene are indicated in Figure 7.3 below.

The “My Five Moments for Hand Hygiene” approach defines the key moments when health-care workers should perform hand hygiene. This evidence-based, field-tested, user-centered approach is designed to be easy to learn, logical and applicable in a wide range of settings.

This approach recommends health-care workers clean their hands:

1. before touching a patient;
2. before clean/aseptic procedures;
3. after body fluid exposure/risk;
4. after touching a patient; and
5. after touching the patient's surroundings.

Source: WHO, 2009, WHO Guidelines on Hand Hygiene in Healthcare

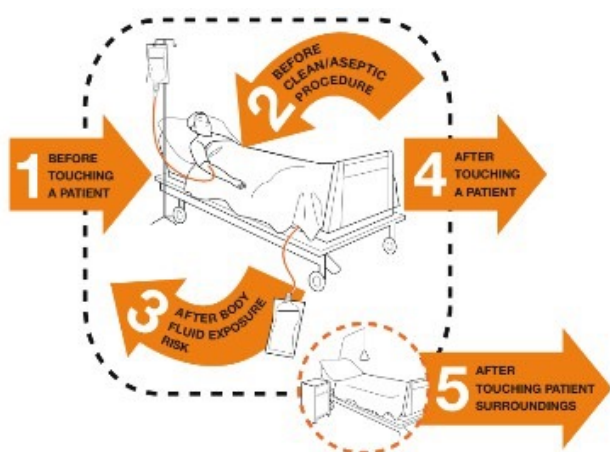

Figure 7.3: The "my five moments of hand hygiene"

### 7.5.3 Education, Communication, Training and Awareness

Everyone within the HCF plays a vital role in the management of HCW, for this reason, the training program shall cast a wide network. Every HCF worker shall be made aware of the policy, the significant health and environmental impacts of their work activities, their roles and responsibilities, the procedure that applies to their work and the importance of conformance with the requirements. The worker shall understand the potential consequences of NOT following the requirements.

Training and continuing education are integral parts of the HCWM system. When health-care personnel are properly sensitized to the importance of waste management, they become advocates for best practices and help to improve and sustain a good waste management system. Importantly, training should be institutionalized and become part of the standard functions of the HCF.

A training module shall be part of the Orientation/Re-orientation Program for newly hired and existing workers to ensure consistency in compliance by all HCF workers. Use of information, Education and Communication (IEC) materials, issuances and advisories shall be utilized to raise awareness and ensure effective implementation of the program. The overall goals of the training are to:

1. Prevent occupational and public health exposures to the hazards associated with HCW;
2. Raise awareness of the health, safety, and environmental issues relating to HCW;
3. Ensure that health-care personnel are

knowledgeable about best practices and technologies for HCWM and are able to apply them in their daily work; and

4. Foster responsibility among all health-care workers for HCWM.

### A. Training of Health-care Workers

Training is essentially the transferring of knowledge, skills, and capacity building of targeted participants. In any HCF, it is mandatory to implement education and training programs to make all the HCF workers aware of the hazards involved in HCW and their specific roles. All HCF workers shall receive training tailored to their different needs at various levels or functions in the HCF.

The overall aim of the training is to develop awareness on the health, safety and, environmental issues related to HCW and how these can affect HCF workers in their daily work. It shall also highlight the roles and responsibilities of the HCF workers.

#### **Separate training activities shall be designed for each of the following targeted categories of personnel:**

- HCF managers and administrative staff responsible for implementing regulations on HCWM;
- Medical doctors;
- Nurses and assistant nurses; and
- Cleaners, porters, auxiliary staff, and waste handlers.

The training for waste generators as well as waste handlers is equally important. Medical doctors may be educated through senior staff workshops and general hospital staff through formal seminars. The training of

waste managers and regulators could take place outside the hospital at public health schools or university departments.

#### **Basic education program for HCF worker shall include:**

- Information on and justification for all aspects of the HCW policy;
- Information on the role and responsibilities of each HCF worker in implementing the policy; and
- Technical instructions, relevant for the target group, on the application of waste management practices.

All HCF workers must receive initial and annual training. A trained individual must be available during training sessions. The instructors shall have experience in teaching and training and be ideally familiar with the hazards and practices of HCWM; they should also have experience in waste handling.

### B. Integrating public education on risk awareness

Promotion of safe and sensible waste handling and disposal is relevant both to users of HCFs and to the wider community as one approach to achieve a better understanding of public health. All HCFs and the FMOH have the responsibility and a “duty of care” for the environment and public health.

The need to promote the appropriate handling and disposal of HCW is important to public health. Every member of the HCF and the community has the right to be informed about the potential health hazards associated with HCW. Inadequate handling of HCW may have serious public health consequences and impacts on environmental health protection.

Public awareness through formal or informal education plays an important role in HCWM.

**Development of IEC programs and materials shall be given due course with the following objectives:**

1. to transmit the basic skills and knowledge in establishing a healthy, secure, and safe environment for HCW and the general public;
2. to inform the public about the risks linked to HCW, focusing on people either living or working near or visiting HCF, families of patients being treated at home and scavengers on waste dumps;
3. to foster responsibility among hospital patients and visitors to HCF regarding hygiene and HCWM;
4. to prevent exposure to HCW and related health hazards, this exposure may be voluntary in the case of scavengers or accidental as a consequence of unsafe disposal methods;
5. to increase awareness of the impact of HCW on the environment and ecology; and
6. to influence the behavior of patients, watchers, HCF workers to implement proper HCWM.

In developing the education, training, information and communication tools, several concerns need to be addressed. These are specifically targeted subjects or participants, including their level of understanding and involvement in the implementation of the HCWM Plan; availability of funds and logistics to sustain the program; support of the HCF management to the program. Training package suggestions for each target group are provided in Annex-6.

# 8 Healthcare waste management in emergencies and pandemics

Natural disasters and conflicts, by their nature, are highly disruptive and dangerous events. Their consequences are unpredictable, and many essential public services will inevitably be interrupted. HCFs, public health and municipal services, such as waste management, may totally or partially cease due to destroyed buildings, damaged equipment, dislocation of staff, a high number of patients and blocked roads.

In such situations, all forms of wastes including hazardous HCW remains uncollected and untreated. Wastes will inevitably accumulate, and serious environmental and health hazards (e.g., COVID 19, hepatitis B and C) may affect communities. Therefore, measures need to be taken to remove wastes as soon as possible after an emergency. The purpose is to reduce the proximity of people to accumulated wastes and so reduce the potential for disease transmission.

## 8.1 Emergency Management Plan

As defined by the WHO “contingency planning and emergency preparedness is a program of long- term development activities whose goals are to strengthen the overall capacity and capability of a country to manage efficiently all types of emergency and to bring an orderly transition from relief through recovery and back to sustain development. The phases for the safe management of HCW in emergencies are described in the succeeding sub-sections.

### 8.1.1 Phase 1: Rapid Initial Assessment

Rapid assessments immediately following a disaster or other emergency are designed to be swift and to inform emergency responders about critical and immediate needs. Initial rapid assessment is likely to be unrefined and should be updated as more data become available. An assessment team shall conduct this initial phase, which may include relief or awareness activities.

To work effectively, the team shall have a clear-cut disposition and priority whether to gather information or perform relief actions. Personnel carrying out assessments are likely to provide initial advice and awareness-raising activities simultaneously. However, a pragmatic balance must be found between the need to act quickly and the need to gather sufficient information to ensure assistance is effective, appropriate to the problems found and sustainable into the future.

#### Issues to remember when collecting information in emergencies:

- Collect information from as many sources as possible to reduce bias and inaccuracies;
- Be aware of local conditions so as not to raise unrealistic expectations;
- Use the data collected as evidence to inform the decisions that must be made;

- Keep good records of what has been learned and from whom, and
- Situations change rapidly in an emergency, and the solutions proposed should be robust and flexible.

More detailed assessments are required during the later disaster management phases as the needs and capabilities of local communities and public organizations evolve. The purpose is to prepare the contributors to the wider relief effort to change over from short-term initial response activities to longer-term rehabilitation.

**Table 8. 1: Key issues to be addressed in a rapid initial assessment**

Aspect	Key Issues
General information	<ul style="list-style-type: none"> <li>Nature and history of the emergency</li> <li>Organization carrying out the assessment</li> <li>Name and position of assessors</li> <li>Dates of the assessment</li> <li>Location of the affected area</li> <li>Logistical resources available</li> <li>Government involvement</li> <li>Existing potential donors</li> <li>Other organizations working in the area, including current and planned activities</li> <li>Institutions and NGOs providing emergency medical care</li> <li>Existing policies, regulations, or guidelines on HCW management</li> <li>Locations and nature of emergency medical care interventions (in tents, field hospitals, mobile HCFs, non-damaged hospitals and health-care centers, HCFs outside of the affected area)</li> </ul>
Demographic data	<ul style="list-style-type: none"> <li>Total population in the affected area</li> <li>Approximate number of affected people</li> </ul>
Geographical information	<ul style="list-style-type: none"> <li>A sketch should be produced, and the following features identified and located: <ul style="list-style-type: none"> <li>Location and type of existing operational medical care activities</li> <li>Location and type of existing operational waste treatment and disposal facilities</li> <li>Burial or cremation sites</li> <li>Location of emergency dumping of HCW</li> <li>If possible, groundwater water levels near the locations of the operational healthcare operations</li> </ul> </li> </ul>

Aspect	Key Issues
General description of the management of HCW in the affected area	<p>The categories of HCW generated by medical care activities</p> <p>Provide any information about HCW quantities. If none exists, make a rough estimation</p> <p>Describe the process of HCW handling in the location of the emergency medical activities</p> <p>Describe the type and number of waste-related equipment available for managing HCW</p> <p>Explain how HCW is disposed</p> <p>Identify any sites near the emergency health-care activities for the controlled burial of HCW</p> <p>Identify who is involved in the handling and disposal of HCW</p> <p>Identify financial resources allocated for handling and disposal of HCW</p> <p>Describe any reported injuries related to HCW (e.g., sharps injuries)</p>

Source: *Safe Management of Wastes from Health-Care Activities, 2nd Edition (WHO, 2014)*

### 8.1.2 Phase 2: Emergency Response

Based on the rapid initial assessment, a simple action plan with clear roles and responsibilities for individuals and emergency response organizations (international bodies, national authorities, civil society) can be developed and resources allocated from the aid effort for implementation. The purpose of HCWM in an emergency is to avoid wastes from being scattered indiscriminately around medical buildings and their grounds and reduce the likelihood of secondary infections.

As a basic starting point, and to avoid sharps injuries, HCW generated by emergency medical care activities (in tents, field hospitals, mobile hospitals) should be segregated using a “two-bin solution” – that is, sorting waste into used sharps and non-sharps wastes (including general wastes and infectious, pathological and pharmaceutical residues). The two bins should be kept segregated until final disposal (see Table 8.2).

#### Basic considerations in emergency response in HCWM:

- All non-sharps wastes, without exception, should be collected in medical areas in rigid containers, such as plastic buckets with a cover, to prevent waste items from being exposed to disease transmission by contact by hand, airborne particles, and flying insects.
- Containers and covers should be washed and disinfected daily after being emptied.
- Reuse of rigid waste containers after disinfection with chlorine (0.2%) solution may be the most practical option to introduce quickly in an emergency and is low cost at a time when resources for better forms of waste segregation and storage may be scarce.

- Sharps wastes should be stored safely in puncture-proof and leak-proof containers.
- Burial of non-sharps and sharps wastes in pits or trenches may be considered as a pragmatic option in emergencies. Burning of HCW is less desirable, but if it is genuinely, the only realistic option in an emergency it should be undertaken in a confined area (burning within a dugout pit, followed by covering with a layer of soil).
- Use gloves for handling HCW;
- Raise the awareness of staff about simple post-exposure prophylaxis in the event of an occupational injury (e.g., needle-stick injury);
- Contain and promptly clean up spillages of infectious materials and disinfect quickly to avoid pathogen transmission;
- Disinfect body fluids before their discharge; and
- Conduct on-site awareness-raising activities (whenever possible) to remind healthcare personnel about occupational exposures and the safe practices for managing HCW.

The following preventive measures can also be implemented during an emergency response phase to reduce public and occupational health risks:

Provide hepatitis B vaccination to all health-care personnel and waste handlers;

- Encourage hand hygiene (washing, preferably followed by disinfection);

Segregated waste should be kept separate until final disposal. General waste should follow a municipal waste disposal route, if available, and sharps and non-sharps wastes should be treated and disposed of using the best available practices based on the minimum options described in the preceding chapters of this Manual.

**Table 8. 2: Segregation of HCW in emergencies**

Waste Category	Typical Waste Items	Type of Container	Color or Mark/Sign
Non-sharps waste	Infectious, pathological waste and some pharmaceutical and chemical residues	Leak-proof container or plastic bag in a holder	Yellow or special mark or sign
Used sharps	Syringes with needles, sutures, blades, broken glass sharps	Leak- and puncture-proof sealable container, box or drum bearing the word “contaminated”	Yellow or special mark or sign
General waste	Similar to municipal wastes, not contaminated by hazardous substances	Container or plastic bag in a holder	Black or special mark or sign

Source: *Safe Management of Wastes from Health-Care Activities, 2nd Edition (WHO, 2014)*



## **A. Minimum treatment and disposal options**

### **On-site burial in pits**

Dig a pit 1–2 meters wide and 2–3 meters deep. The bottom of the pit should be at least 2 meters above the groundwater. Line the bottom of the pit with clay or permeable material. Construct an earth mound around the mouth of the pit to prevent water from entering. Construct a fence around the area to prevent unauthorized entry. Inside the pit, place alternating layers of waste, covered with 10cm of soil (if it is not possible to layer with soil, alternate the waste layers with lime). When the pit is within about 50cm of the ground surface, cover the waste with soil and permanently seal with cement and embedded wire mesh.

### **Burial in special cells in dumping sites (if available in the affected area)**

Cells to contain waste can be used when burying waste in dumping sites. The cell should be at least 10 meters long and 3 meters wide, and 1–2 meters deep. The bottom of the cell should be at least 2 meters above the groundwater. The bottom of the cell should be covered by soil or material with low permeability. The waste in the cell should be covered immediately with 10-cm layers of soil to prevent access by people or animals (in disease outbreaks like COVID 19, preferably spread lime on waste before covering with the soil). It is strongly recommended that HCW be transported safely to minimize public exposure to bio-contaminated wastes.

### **Low-cost double-chamber incinerators**

Double-chamber incinerators may reach a temperature of about 800°C with a residence time of more than one second in the second

chamber to kill pathogens and break down some of the particulates in the outlet gases. The incinerators should be built at a convenient distance away from buildings. Such incinerators need to be heated with paper, wood, or dry non-toxic waste (small quantities of kerosene may be added, if available) before adding infectious wastes.

### **Encapsulation**

Place sharps wastes or pharmaceutical wastes in hard containers, such as metal drums, and add an immobilizing material, such as cement, bituminous sand, or clay. When dry, the drum or container can be sealed and buried in a local landfill or a pit in the HCF.

### **Spill control**

Spillages require cleanup of the area contaminated by the spilled waste. For spillages of highly infectious material, it is important to determine the type of infectious agent, because the immediate evacuation of the area may be necessary in some cases.

In general, the most hazardous spillages occur in laboratories rather than in medical care departments. The Infection Control Officer can be asked for assistance regarding proper management and cleanup of the spill due to infectious waste.

Procedures for dealing with spillage shall specify safe handling operations and appropriate protective clothing. In case of skin and eye contact with hazardous substances, there shall be immediate decontamination. The exposed person shall be removed from the area of the incident for decontamination, generally with copious amounts of water. Special attention shall be paid to the eyes and any open wounds. In case of eye contact

with corrosive chemicals, the eyes shall be irrigated continuously with clean water for 10 – 30 minutes; the entire face shall be washed in a basin, with the eyes being continuously opened and closed. An eyewash assembly can be installed in the unit for immediate response. Standard Operating Procedures (SOP) for emergency response procedures for waste biological spills are provided in Annex-7.

### 8.1.3 Phase 3: Recovery Phase

The recovery phase can be characterized as a longer-term program of assistance to return an affected community to a normal situation similar to that, which existed before the disaster or, potentially, better. As resources become available, a more detailed assessment can be conducted for planning and fundraising for future improvements, and for setting priorities in the affected area.

The results of the assessment and the identified needs and priorities are the starting point for ensuring that a sustainable approach to HCWM is created after an emergency. Start by preparing simple, locally applicable action plans to define the improvements to be achieved, and gradually improve these action plans whenever the resources become available.

#### **Key points to address during a recovery phase:**

- Existing procedures and practices of HCWM;
- Responsibility for the management of HCW;
- Presence of an infection-control committee to oversee improvements and training;

- Dedicated equipment for storage, collection, and on-site and off-site transportation of HCW;
- Availability of on-site and off-site HCW treatment facilities;
- Availability of on-site and off-site disposal facilities;
- Level of health-care personnel awareness about the risks associated with HCW;
- Staff health protection (protective clothing, vaccination); and
- Financial aspects related to HCWM and associated infection-control procedures, and a means to sustain funds to operate waste management in the future.

Recovery phase activities in the HCF after an accident, incident and emergencies can include the following:

- Preparation of incident/accident report (Refer to Annex-8 for a sample occupational
- Incident/Accident Report (OIR) Form);
- Inventory of used items;
- Provision of new supplies to replace the used items in the kit; and
- Psychosocial debriefing of the injured person, as necessary.

All waste management staff should be trained in emergency response and made aware of the correct procedure for prompt reporting. Accidents or incidents, including near misses, spillages, damaged containers, inappropriate segregation, and any incidents involving sharps, should be reported to the waste management officer (if waste is involved) or to another designated person.

**The accident report should include details of:**

- The nature and magnitude of the accident or incident;
- The place, date and time of the accident or incident;
- The staff who is directly involved;
- Immediate response taken;
- Any other relevant circumstances; and
- Recommendations, if any.

The waste management officer or another responsible officer, who shall take possible action to prevent recurrence, shall investigate the cause of the accident or incident. The records of the investigation and recommendations must be submitted to the management for review and approval. Any amendment in the policies and procedural guidelines must be integrated into the HCWM Plan of the HCF. Updates shall be disseminated to all HCF workers for information and guidance. All records of spill management must be kept for future reference.

## **8.2 Contingency Planning and Emergency Preparedness**

At the HCF level, action plans on HCWM should include temporary measures to apply during emergencies.

**The contingency plans should address the following questions:**

- What standards will be used to guide a response?
- What are the current capacities of the agencies or organizations to respond?

- What initial assessment arrangements are needed?
- What actions will be taken as an immediate response to the situation?
- Who does what and when? Who is coordinating and leading?
- What resources would be needed?
- How will information flow between the various levels (local and national)?
- Have specific preparedness actions be agreed on and practiced?

Contingency planning needs to be seen as a continuing process that is regularly reviewed and updated to ensure that all partners are familiar with their various roles, responsibilities and actions to be undertaken. Contingency plans should be in line with existing national policies and legislation.

## **8.3 Emerging Issues**

### **8.3.1 Emerging Diseases and Multidrug-resistant Organisms**

Among the most important diseases considered as emerging are those becoming increasingly resistant to the established medical treatments. These include extremely drug-resistant tuberculosis, methicillin-resistant and vancomycin-resistant *Staphylococcus aureus*, and malaria (chloroquine - resistant *Plasmodium falciparum*, and strains that are resistant to the antifolate combination drugs and atovaquone). *Clostridium difficile* too has recently caused much concern as a resistant nosocomial infection (Loo et al., 2005).

Waste-treatment practices may need to be adapted to ensure that novel organisms are inactivated properly. Standardized test strips containing heat-resistant bacterial spores are assumed to demonstrate that processes to inactivate the spores will also be effective with other pathogens. However, some pathogens – such as prions – are difficult to inactivate. Testing protocols, including test strip design, need to be updated regularly in the light of new data on pathogen resistance.

### 8.3.2 Pandemics

Pandemics have always occurred periodically. They may be catalyzed by factors including the increase in international travel and movement of populations or disease vectors. It is generally assumed that the amount of HCW will increase during pandemics, but if non-emergency medical operations and other treatments are postponed, the amount of wastes may be lower. The mode of transmission will be another significant factor. If a pandemic is spread by contact, even general waste from medical areas may potentially have to be classified as infectious HCW.

Where a vaccine is available, the quantity of sharps waste and empty vials will increase significantly. Fortunately, these wastes are comparatively easy to store and so should not create an insurmountable HCW problem, unless produced in underdeveloped regions. Any increase in vaccination waste may be partially offset by a reduction in routine injections. The status of waste management staff should be considered. Unlike health workers, they are generally not included in lists of essential workers who should be prioritized for vaccination. Consequently, there may be significant staff shortages and subsequent loss of capacity for waste

management staff. This would be most acute where HCW treatment and disposal are conducted at centralized plants away from HCFs.

In their contingency plans to address medical emergencies, HCFs should include the use of HCW engineering advice, realistic transportation and disposal arrangements, and the regular vaccination of waste workers. This is a prudent approach to maintaining a sufficient level of public health protection through prompt waste removal and processing during an emergency.

### Health-care waste management during COVID 19

In low-income countries like Ethiopia, HCW is often not separated into hazardous or non-hazardous waste, making the real quantity of hazardous waste much higher. The current pandemic of coronavirus disease (COVID 19) brings an additional challenge in the waste management of healthcare facilities. Hospitals, health centers and temporary COVID 19 treatment centers produce more waste than usual during COVID 19. The diagnosis and treatment of COVID 19 produce wastes that include masks, gloves, gowns, and other personal protective equipment that could be infected with the virus. Besides the amount of single-use masks, and other personal protective equipment used greatly increased which later results in huge volume of infectious waste per day. Inappropriate management of this waste during COVID 19, not only from HCFs but from home quarantine and treatment too, can predispose healthcare workers, patients, and the general public to coronavirus since the virus can survive on inanimate objects and different surfaces for a longer time.

The World Health Organization (WHO) recommends that all HCWs produced during the care of COVID-19 patients should be collected safely in designated containers and bags, treated, and then safely disposed of or treated, or both, preferably on-site. Furthermore, if waste is moved off-site, it is critical to understand where and how it will be treated and destroyed. All who handle HCW should wear appropriate personal protective equipment (PPE) and perform hand hygiene after removing it. Similarly, as per the recommendations of both the Ministry of Health (Ethiopia) and the Ethiopian Public Health Institute, all HCWs produced during the care of COVID-19 patients

must be considered as infectious waste and should be collected safely in designated containers and bags, treated, and then safely disposed.

The standard operating procedures described below can be considered as the minimum requirement health-care waste management for Ethiopia during COVID 19.

#### **A. General instructions for COVID 19 waste management**

1. All health care wastes produced during the care of COVID 19 patients in a health care facility, isolation facility and a quarantine facility must be considered as infectious waste and should be collected safely in designated containers and bags, treated and then safely disposed as general waste or incinerated or burnt as recommended by Ministry of Health.
2. Staff handling waste should be properly trained and educated on the use of personal protective equipment, hand hygiene, personal hygiene and respiratory etiquettes.

3. Ensure necessary PPE is worn when handling health care waste (waterproof clothing (top/pants) heavy-duty gloves/ thick gloves, surgical masks, face shield and closed shoes/gumboots) by all staff.
4. Strictly maintain physical distance between people with not less than 6 feet
5. If any waste handler develops fever and respiratory symptoms, inform the supervisor and seek medical help.
6. Drivers and collectors should avoid contact with residents and employees.
7. Clean work clothes and shoes daily and wash with detergent and water.

#### **B. Infection prevention and control measures**

1. Health care waste handlers must ensure to wear the following PPE's; heavy-duty gloves, gowns, face shield or goggle, surgical mask, gumboots or closed shoe
2. Use correct techniques for putting the mask on and taking it off (Refer to Annex 10 and 11).
3. Replace gloves in the event of breakage or any incident of potential contamination
4. Frequent handwashing with soap and water for 20 seconds or sanitizing hands should be ensured

#### **C. Waste segregation**

1. Infectious waste, sharp waste and general waste must be segregated and bins labelled properly
2. Bins should be double bagged.
3. When 2/3rd full the bag should be removed, tied properly and then labelled as infectious waste, date and the name of the institution

#### **D. Cleaning the waste bin**

1. Direct contact (without gloves) with bins or bags should be strictly avoided.
2. The dustbins must be cleaned after the removal of waste.
3. First, clean the dustbin properly with detergent and water and then clean the dustbins with 1:9 (mix 100 mL bleach in 900 mL water, use within 24 hours) 1-part bleach and 9 parts water) bleach solution and dry

#### **E. Cleaning the vehicle**

1. The vehicle used to transfer wastes to the waste disposal site/municipal waste site must be cleaned immediately after transportation.
2. First, clean the vehicle properly with detergent and water and then disinfect with bleach solution.
3. Make sure that there are disinfectants and hand sanitizers available in all vehicles.

#### **F. Offsite transportation of health care waste**

1. Designate a specific vehicle for the transfer of wastes from HCF
2. Designate separate, lidded bins to collect and transport wastes in vehicle
3. Ensure the staffs wear PPE when transporting waste
4. Ensure the staffs handle waste according to the guideline

#### **G. Treatment and disposal of health care waste**

1. It is advised to autoclave health care waste inside the facility and then sends it as general waste to the municipal waste site (Figure 8.1)
2. If there is no autoclave follow the below procedure as instructed in Figure 8.2 during COVID 19 pandemic;
3. remove/cut the lid of an empty oil barrel (standard size)
4. cover 30 to 40 cm of the barrel with sand
5. put waste on top of the sand and burn
6. burn waste away from households, health care facilities

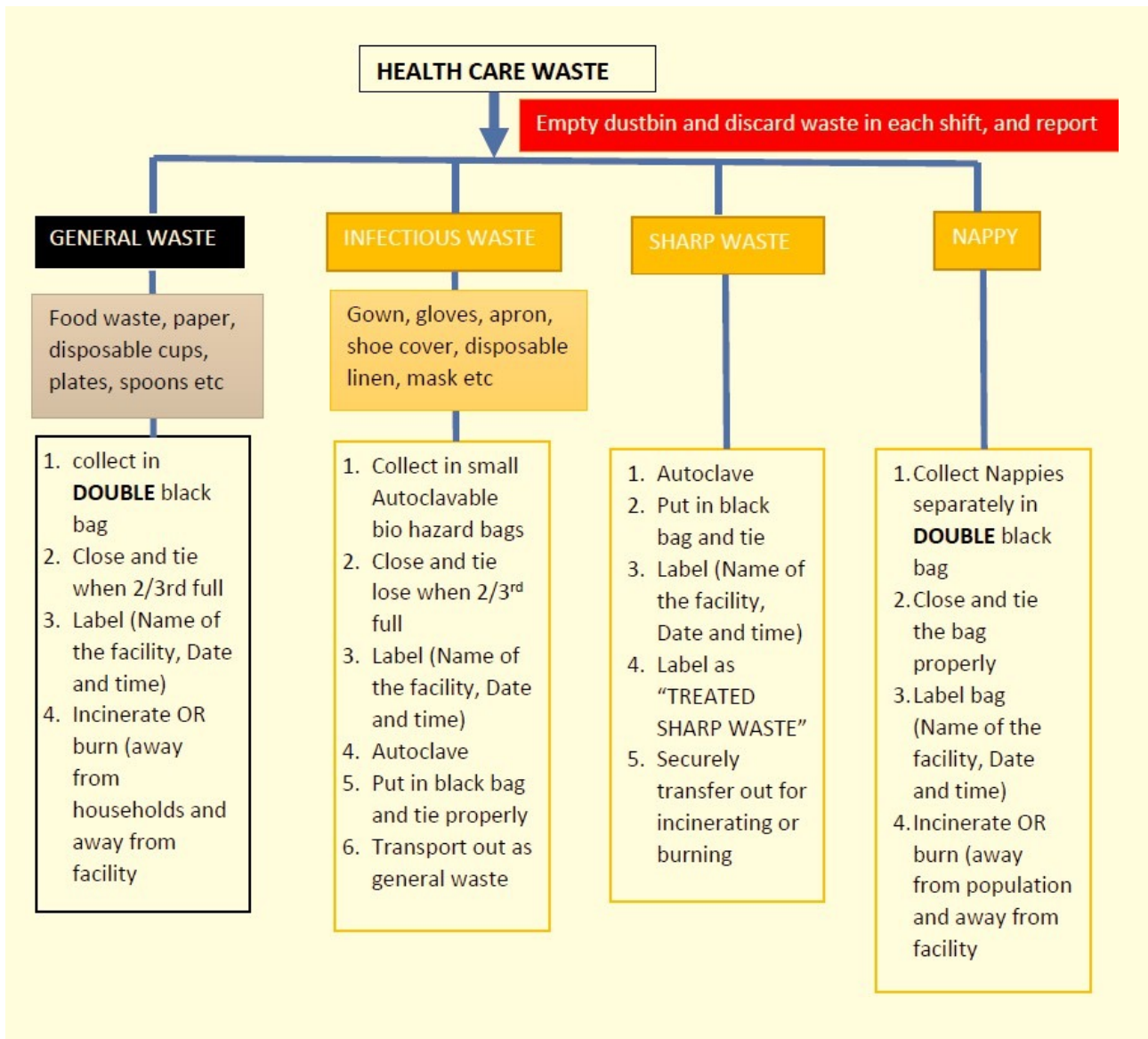
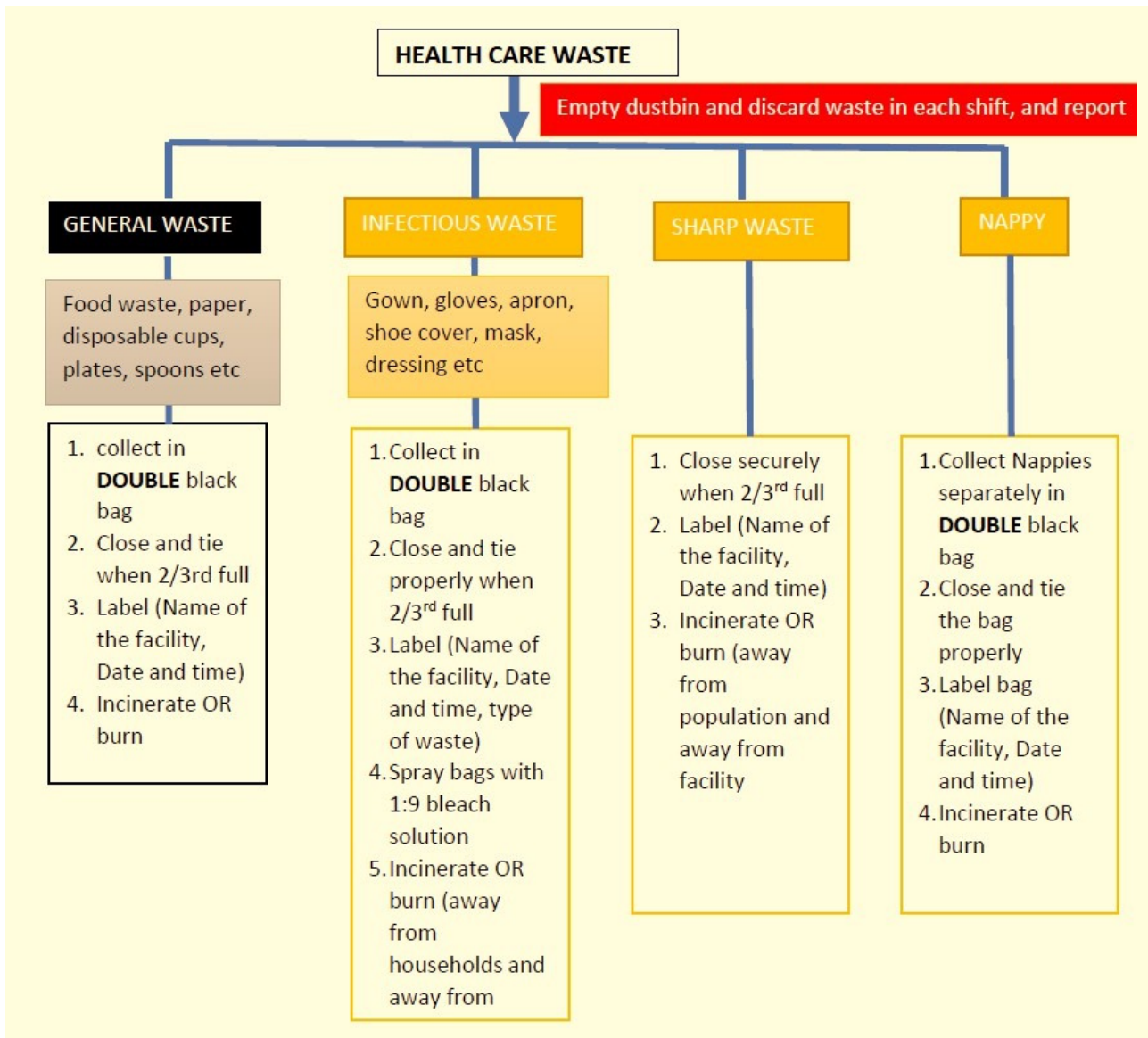

Figure 8. 1: Procedure for waste disposal in HCF's with a waste autoclave



**Figure 8. 2: Procedure for waste disposal in HCF's with no waste autoclave**

### 8.3.3 Climate Change

Climate change is likely to affect all aspects of life, and waste management is no exception. Gradual climatic trends and extreme weather events can disrupt services in the short term and affect long-term capacity requirements. Waste-disposal sites are often built on marginal sites, such as marshlands, flood plains and coastal areas, and many may become increasingly vulnerable to flooding where average sea and river levels rise, or more frequent extreme weather events

inundate the land.

Shorter duration weather changes, such as seasonal floods and heatwaves, may be particularly problematic in rural areas, where resilience in waste-collection systems may be lower. This can be countered by decentralizing waste treatment and increasing storage capacity, as well as undertaking contingency or continuity planning at the facility and national levels. Fuel and power costs are predicted to rise, and power shortages may



become more common. Planners should promote the adoption of lower energy technologies wherever possible. Installation of renewable energy generation capacity, particularly at remote installations, would reduce vulnerability.

### 8.3.4 Other Environmental Issues

The list of pharmaceuticals, other HCF-derived chemicals and disinfection by-products present in wastewater and the environment is increasing. Even though their impacts on humans and the ecosystem vary, they are becoming more widely understood. Overuse of antimicrobials can simultaneously drive bacterial resistance and cause pollution. Glutaraldehyde, triclosan and silver are among the best known. Silver is now found in many medical devices, soaps, textiles, furnishings, and construction materials targeted at hospitals. However, some bacteria rapidly build up resistance to silver by a mechanism that could also make them resistant to antibiotics, particularly the beta-lactams.

Resistance can also build up in bacteria in sewage treatment works and the wider environment if they are polluted with antimicrobials released from products. The only way to avoid these twin problems is through the segregation and treatment of wastes containing these antimicrobials, or their recovery from wastewaters. Since this is currently not practiced and is unlikely to be feasible soon, the use of these products should be kept to a minimum.

Chlorine-based disinfectants are widely used. However, chlorine can cause pollution by reacting with organic chemicals in liquid wastes to create toxic organochlorines. If materials such as infected plastics have been soaked in chlorine before incineration, the amount of chlorinated dioxins and furans produced will be elevated. Alternatives that can be equally or even more effective as disinfectants include hydrogen peroxide or ozone, either alone or in combination with ultraviolet light.

**Table 8. 3: Summary of key points relating to environmental issues**

Issues	Response Options
<ul style="list-style-type: none"> <li>■ There is a need to reduce toxic chemicals in wastewater and in other emissions from HCW disposal.</li> <li>■ Overuse of antimicrobials increases pathogen resistance.</li> <li>■ The availability of authorized landfill capacity is decreasing, and the costs of operation are increasing.</li> <li>■ Environmental protection requirements and costs will increase.</li> </ul>	<ul style="list-style-type: none"> <li>■ Prioritize pollution prevention over pollution control and avoid the use of toxic materials wherever possible.</li> <li>■ Improve wastewater treatment and avoid disposing of chemicals to the sewer.</li> <li>■ Avoid overuse of microbial chemicals, especially silver triclosan and glutaraldehyde.</li> <li>■ Replace chlorine as a disinfectant with hydrogen peroxide, ozone, and ultraviolet alternatives.</li> </ul>

Source: *Safe Management of Wastes from Health-Care Activities, 2nd Edition (WHO, 2014)*

## Annex 1: Sample Assessment Checklist for Small HCFs for the Development of HCWM

---

Name of HCF: \_\_\_\_\_

Type of HCF: \_\_\_\_\_

Location: \_\_\_\_\_

---

General Information

---

Number of employees/workers \_\_\_\_\_

---

Bed capacity \_\_\_\_\_

---

Bed occupancy rate \_\_\_\_\_

---

List all medical and supporting departments of the facility. (including pharmacy, laboratories, kitchen etc.) \_\_\_\_\_

---

Health-care Waste Management

---

What are the wastes generated daily by each department or ward/lab in the HCF? (Please check) \_\_\_\_\_

\_\_\_\_\_General non-infectious wastes

\_\_\_\_\_Sharps

\_\_\_\_\_Pharmaceutical wastes

\_\_\_\_\_Chemical wastes

\_\_\_\_\_Pathological wastes

\_\_\_\_\_Anatomical wastes

---

How much is generated per type of waste by each department or ward/lab in the HCF? (kg/day) \_\_\_\_\_

\_\_\_\_\_General non-infectious wastes

\_\_\_\_\_Sharps

\_\_\_\_\_Pharmaceutical wastes

\_\_\_\_\_Chemical wastes

\_\_\_\_\_Pathological wastes

\_\_\_\_\_Anatomical wastes

---

Is the HCF practicing segregation at point source? \_\_\_\_\_

---

Are there functional waste collection containers in close proximity to all waste generation points for non-infectious wastes, infectious waste and sharp wastes? \_\_\_\_\_

---

How and where the facility's is HCW stored before collection? \_\_\_\_\_

---

Are the wastes stored separately? \_\_\_\_\_

---

Are all the infectious wastes stored in a protected area before treatment for no longer than the default and safe time? \_\_\_\_\_

---

---

How is hazardous liquid waste handled? Specify for chemical waste, cytotoxic waste, reagents, and used x-ray film processing liquids.

If the liquid waste is discharged in the sanitation system, where does the latter discharge and what is its capacity?

---

#### HCWM Treatment and Disposal

---

What acceptable treatment technology (if any) are done to the wastes before disposal?

---

Is the HCW disposed of at the HCF or off-site?

---

If the wastes are disposed at the facility:

Are concrete vaults used for the disposal of sharp wastes? Are placentas disinfected prior to disposal to placenta pit?

Are treated infectious wastes, sharps, chemical and pharmaceutical waste encapsulated/inert sized and disposed through safe burial?

---

If any waste is taken off-site, are the wastes transported for treatment by a DENR-accredited transporter? How is the waste packaged? What types of vehicles are used to transport the waste?

---

Is any of the waste taken to a dump or landfill site?

---

If so, what happens to the waste at this facility?

Is the HCW buried immediately after arriving at the landfill/dump?

---

Is it burned on the site?

Is it left unattended at any time after being unloaded?

Do waste pickers, children, or others have access to the HCF?

---

#### Wastewater Management

---

What are the uses of water in the facility?

---

What departments/wards in the HCF generate wastewater? Estimate volume generated.

---

Is the wastewater treated on-site or treated in a centralized wastewater treatment facility?

---

#### Management

---

Is there a trained person responsible for the management of health-care wastes in the healthcare? facility?

---

How many people are involved in waste collection and are special skills required by the HCF? What sort of worker safety measures is in place?

---

What are the current operational standards for HCW and what are the applicable national, regional? and local policies?

---

Are there any written standard operating procedures for the segregation, storage, treatment and disposal of the health-care wastes?

---

Are appropriate protective equipment provided to all staff in charge of the waste management?

---

---

Is procurement of new health-care materials reviewed to reduce the waste stream and to avoid potential treatment problems (such as PVC)?

---

What are the daily waste collection routines, including waste packaging?

---

How much does HCW management cost the facility? Does the budget provision cover these costs?

---

Risks of the current waste management system

---

Does the management of the HCF have concerns about the facility's current HCW practices? If so, what problems do they identify?

---

Does the assessment above indicate that the facility's current waste management practices pose any health risks to patients, nurses or doctors, other staff, or visitors? If yes, what kind of risks?

---

Does the waste pose any risk to waste collectors? If yes, what kind?

---

*Source: Health-care Waste Management Guidance Note (World Bank, 2000)  
Water and Sanitation for Health Facility Improvement Tool (WHO, 2018)*

**Annex-2: Symbols from the European Commission’s Directive on dangerous substances (in the left-hand column) and those from the United Nations Economic Commission for Europe’s (UNECE’s) globally harmonized system of classification and labelling of chemicals (in the right-hand column)**



**Corrosive (C)**

These substances attack and destroy living tissues, including the eyes and skin.



**Highly flammable (F)**

These substances easily catch fire (flash point: 21–55 °C). Never store flammable substances together with explosive ones.



**Toxic (T)**

These substances can cause death. They may have their effects when swallowed or breathed in, or when absorbed through the skin.



**Harmful (Xn)**

These substances are similar to toxic substances but are less dangerous.



**Explosive (E)**

An explosive is a compound or mixture susceptible to a rapid chemical reaction, decomposition or combustion, with the rapid generation of heat and gases with a combined volume much larger than the original substance.



**Irritant (I)**

These substances can cause reddening or blistering of skin.





**Extremely flammable (F+)**

Liquid substances and preparations that have an extremely low flash point (<21 °C) and therefore catch fire very easily.



**Very toxic (T+)**

Substances and preparations that, in very low quantities, cause death or acute or chronic damage to health when inhaled, swallowed or absorbed via the skin.



**Oxidising (O)**

These substances provide oxygen, which allows other materials to burn more fiercely.



**Dangerous for environment (N)**

Substances that, were they to enter into the environment, would present or might present an immediate or delayed danger for one or more components of the environment.



**Specific organ toxicity**

No direct equivalent; use harmful or irritant symbol as appropriate

These substances may cause:

- damage to organ or organs after single or repeated exposure
- respiratory sensitization
- allergy or asthma or breathing difficulties if inhaled.



WHO, Health-care waste management, 2014

## Standard precautions in health care

### Background

Standard precautions are meant to reduce the risk of transmission of bloodborne and other pathogens from both recognized and unrecognized sources.

They are the basic level of infection control precautions which are to be used, as a minimum, in the care of all patients.

Hand hygiene is a major component of standard precautions and one of the most effective methods to prevent transmission of pathogens associated with health care. In addition to hand hygiene, the use of personal protective equipment should be guided by risk assessment and the extent of contact anticipated with blood and body fluids, or pathogens.

In addition to practices carried out by health workers when providing care, all individuals (including patients and visitors) should comply with infection control practices in health-care settings. The control of spread of pathogens from the source is key to avoid transmission. Among source control measures, respiratory hygiene/cough etiquette, developed during the severe acute respiratory syndrome (SARS) outbreak, is now considered as part of standard precautions.

Worldwide escalation of the use of standard precautions would reduce unnecessary risks associated with health care. Promotion of an institutional safety climate helps to improve conformity with recommended measures and thus subsequent risk reduction. Provision of adequate staff and supplies, together with leadership and education of health workers, patients, and visitors, is critical for an enhanced safety climate in health-care settings.

### Important advice

- Promotion of a safety climate is a cornerstone of prevention of transmission of pathogens in health care.
- Standard precautions should be the minimum level of precautions used when providing care for all patients.
- Risk assessment is critical. Assess all health-care activities to determine the personal protection that is indicated.
- Implement source control measures for all persons with respiratory symptoms through promotion of respiratory hygiene and cough etiquette.

### ✓ Checklist

#### Health policy

- Promote a safety climate.
- Develop policies which facilitate the implementation of infection control measures.

#### Hand hygiene

- Perform hand hygiene by means of hand rubbing or hand washing (see detailed indications in table).
- Perform hand washing with soap and water if hands are visibly soiled, or exposure to spore-forming organisms is proven or strongly suspected, or after using the restroom. Otherwise, if resources permit, perform hand rubbing with an alcohol-based preparation.
- Ensure availability of hand-washing facilities with clean running water.
- Ensure availability of hand hygiene products (clean water, soap, single use clean towels, alcohol-based hand rub). Alcohol-based hand rubs should ideally be available at the point of care.

#### Personal protective equipment (PPE)

- ASSESS THE RISK of exposure to body substances or contaminated surfaces BEFORE any health-care activity. **Make this a routine!**
- Select PPE based on the assessment of risk:
  - clean non-sterile gloves
  - clean, non-sterile fluid-resistant gown
  - mask and eye protection or a face shield.

#### Respiratory hygiene and cough etiquette

- Education of health workers, patients and visitors.
- Covering mouth and nose when coughing or sneezing.
- Hand hygiene after contact with respiratory secretions.
- Spatial separation of persons with acute febrile respiratory symptoms.



# Health-care facility recommendations for standard precautions

## KEY ELEMENTS AT A GLANCE

### 1. Hand hygiene<sup>1</sup>

#### Summary technique:

- Hand washing (40–60 sec): wet hands and apply soap; rub all surfaces; rinse hands and dry thoroughly with a single use towel; use towel to turn off faucet.
- Hand rubbing (20–30 sec): apply enough product to cover all areas of the hands; rub hands until dry.

#### Summary indications:

- Before and after any direct patient contact and between patients, whether or not gloves are worn.
- Immediately after gloves are removed.
- Before handling an invasive device.
- After touching blood, body fluids, secretions, excretions, non-intact skin, and contaminated items, even if gloves are worn.
- During patient care, when moving from a contaminated to a clean body site of the patient.
- After contact with inanimate objects in the immediate vicinity of the patient.

### 2. Gloves

- Wear when touching blood, body fluids, secretions, excretions, mucous membranes, nonintact skin.
- Change between tasks and procedures on the same patient after contact with potentially infectious material.
- Remove after use, before touching non-contaminated items and surfaces, and before going to another patient. Perform hand hygiene immediately after removal.

### 3. Facial protection (eyes, nose, and mouth)

- Wear (1) a surgical or procedure mask and eye protection (eye visor, goggles) or (2) a face shield to protect mucous membranes of the eyes, nose, and mouth during activities that are likely to generate splashes or sprays of blood, body fluids, secretions, and excretions.

### 4. Gown

- Wear to protect skin and prevent soiling of clothing during activities that are likely to generate splashes or sprays of blood, body fluids, secretions, or excretions.
- Remove soiled gown as soon as possible, and perform hand hygiene.

### 5. Prevention of needle stick and injuries from other sharp instruments<sup>2</sup>

#### Use care when:

- Handling needles, scalpels, and other sharp instruments or devices.
- Cleaning used instruments.
- Disposing of used needles and other sharp instruments.

### 6. Respiratory hygiene and cough etiquette

#### Persons with respiratory symptoms should apply source control measures:

- Cover their nose and mouth when coughing/sneezing with tissue or mask, dispose of used tissues and masks, and perform hand hygiene after contact with respiratory secretions.

#### Health-care facilities should:

- Place acute febrile respiratory symptomatic patients at least 1 metre (3 feet) away from others in common waiting areas, if possible.
- Post visual alerts at the entrance to health-care facilities instructing persons with respiratory symptoms to practise respiratory hygiene/cough etiquette.
- Consider making hand hygiene resources, tissues and masks available in common areas and areas used for the evaluation of patients with respiratory illnesses.

### 7. Environmental cleaning

- Use adequate procedures for the routine cleaning and disinfection of environmental and other frequently touched surfaces.

### 8. Linens

#### Handle, transport, and process used linen in a manner which:

- Prevents skin and mucous membrane exposures and contamination of clothing.
- Avoids transfer of pathogens to other patients and/or the environment.

### 9. Waste disposal

- Ensure safe waste management.
- Treat waste contaminated with blood, body fluids, secretions and excretions as clinical waste, in accordance with local regulations.
- Human tissues and laboratory waste that is directly associated with specimen processing should also be treated as clinical waste.
- Discard single use items properly.

### 10. Patient care equipment

- Handle equipment soiled with blood, body fluids, secretions, and excretions in a manner that prevents skin and mucous membrane exposures, contamination of clothing, and transfer of pathogens to other patients or the environment.
- Clean, disinfect, and reprocess reusable equipment appropriately before use with another patient.

<sup>1</sup> For more details, see: WHO Guidelines on Hand Hygiene in Health Care (Advanced draft), at: [http://www.who.int/patientsafety/information\\_centre/ghhad\\_download/en/index.html](http://www.who.int/patientsafety/information_centre/ghhad_download/en/index.html).

<sup>2</sup> The SIGN Alliance at: [http://www.who.int/injection\\_safety/sign/en/](http://www.who.int/injection_safety/sign/en/)



## Annex-4: Proper hand hygiene procedure-Hand rub

# How to Handrub?

RUB HANDS FOR HAND HYGIENE! WASH HANDS WHEN VISIBLY SOILED

**⌚** Duration of the entire procedure: 20–30 seconds



World Health  
Organization

Patient Safety  
A Whole Alliance for Better Health Care

SAVE LIVES  
Clean Your Hands

© 2009 World Health Organization. All rights reserved. This document is licensed under a Creative Commons Attribution-NonCommercial-ShareAlike license. For more information, see <http://creativecommons.org/licenses/by-nc-sa/4.0/>. The responsibility for the interpretation and use of the information is with the reader. In no way shall the World Health Organization be liable for damages arising from its use. WHO acknowledges the Regional Directorates of Geneva (SDG) in particular the members of the Infection Control Programme, for their active participation in developing this material.

May 2009

WHO, Health-care waste management, 2014

## Annex-5: Proper hand hygiene procedure-Handwash

# How to Handwash?

WASH HANDS WHEN VISIBLY SOILED! OTHERWISE, USE HANDRUB

 Duration of the entire procedure: 40–60 seconds



0 Wet hands with water



1 Apply enough soap to cover all hand surfaces



2 Rub hands palm to palm



3 Right palm over left dorsum with interlaced fingers and vice versa



4 Palm to palm with fingers interlaced



5 Backs of fingers to opposing palms with fingers interlocked



6 Rotational rubbing of left thumb clasped in right palm and vice versa



7 Rotational rubbing, backwards and forwards with clasped fingers of right hand in left palm and vice versa



8 Rinse hands with water



9 Dry hands thoroughly with a single use towel



10 Use towel to turn off faucet



11 Your hands are now safe



World Health  
Organization

Patient Safety

A World Alliance for Safer Health Care

SAVE LIVES

Clean Your Hands

All reasonable precautions have been taken by the World Health Organization to verify the information contained in this document. However, the published material is being distributed without warranty of any kind, either expressed or implied. The responsibility for the interpretation and use of the material lies with the reader. In no event shall the World Health Organization be liable for damages arising from its use.

WHO acknowledges the Médecins Sans Frontières (MSF) in particular the members of the Infection Control Programme, for their active participation in developing this material.

May 2009

WHO, Health-care waste management, 2014

## Annex-6: Sample training in Health-care Waste Management

Course code	Title	Credits
BHM-001	Fundamentals: Environment and health, healthcare waste management regulation	4
	Block 1: Understanding our environment Unit 1: Introduction to the environment Unit 2: Environmental pollutants Unit 3: Interrelationship of environment and health Unit 4: Waste management	1
	Block 2: Health-care waste definitions Unit1: Definitions, types and categories of waste Unit 2: Principles of health-care waste management Unit 3: Handling health-care waste	1
	Block 3: Need for sound healthcare waste management Unit1: Impact of health-care waste on our environment Unit 2: Impact of health-care waste on human health Unit 3: Safety methodology, worker safety and precautions	1
	Block 4: current status of health-care waste management in African countries Unit 1: Rules and legislations Unit 2: Regulatory mechanism Unit 3: Current status in East Africa Unit 4: Current status in Ethiopia	1

BHM-002	Health-care waste management: concepts, technologies and training	6
	Block 1: Practical aspects of health-care waste management Unit 1: Managerial and administrative aspects Unit 2: Integrated infection control management Unit 3: Disinfection and transportation Unit 4: Capacity building, training and monitoring	2
	Block 2: Systems and technologies in healthcare waste management Unit 1: Systems options Unit 2: Treatment and disposal of health-care waste: burn technologies Unit 3: Treatment and disposal of health-care waste: non-burn technologies Unit 4: Innovative concepts and possibilities	2
	Block 3: Health-care waste management and emerging issues Unit 1: Managing wastewater from health-care facilities Unit 2: Management of waste from immunizations Unit 3: Occupation and patient safety Unit 4: Success stories	1
	Block 4: Training manual for waste handlers	1
BHM-001	Project	4

WHO, *Health-care waste management*, 2014

## Annex-7: Biological Spill Clean-up – SOP

The purpose of this SOP is to standardize the specific procedures to be used for the facility. This document should be customized to meet your facility's needs.

### 1. Purpose

This document outlines procedures for cleaning up a biological spill.

### 2. Scope

Handling of infectious medical waste and other hazardous substances always poses a risk of spills; therefore, staff members must be trained to handle such situations and procedures must be prepared. The sequence of the actions depends on the situation. Evacuation of personnel from the contaminated area, disinfection of skin and eyes of people affected by the incident, and treatment of injuries must take priority.

### 3. Definitions

**Biological waste** – a combination of biomedical, infectious, pathological and sharps waste.

**Decontamination** – any process for removing and/or killing microorganisms. The same term is also used for removing or neutralizing hazardous chemicals and radioactive materials.

**Disinfectant** – a chemical or mixture of chemicals used to kill microorganisms, but not necessarily spores. Disinfectants are usually applied to inanimate surfaces or objects.

**Disinfection** – the reduction or removal of pathogens to minimize the potential for disease transmission.

### 4. Responsibilities

Proper incident management requires appropriate training, so everyone knows how an incident must be handled.

### 5. Materials and Equipment

Personal protection equipment

- Impervious cut safe disposable gloves
- Goggles and/or face shield
- Safety shoes
- Apron

## Spill kit

- Effective disinfectant agent (i.e., 10% bleach made fresh daily, clidox, 2% amphyl, etc.)
- Absorbent paper towels; may also include spill pillows for large spills
- Small disposable broom with dustpan
- Infectious medical waste bags
- A waterproof copy of spill response and cleanup procedures

## 6. Hazards and Safety Concerns

In all situations, PPE must be used, including goggles, masks, gloves, coveralls, apron, etc. No cleaning action should be initiated without proper use of appropriate and approved PPE.

## 7. Procedures

### 7.1. Prepare to clean up

7.1.1. A general review of the incident must be conducted immediately after the incident has taken place or has been discovered.

7.1.2. Contaminated areas must be cordoned off as soon as possible and not released before proper cleaning has been carried out.

7.1.3. All involved persons must be checked for injuries and possible contamination and then treated accordingly.

7.1.4. Involved persons must not leave the incident area before they have been checked in order to prevent spreading of infectious or chemical materials to other areas of the facility.

7.1.5. Names of all involved persons must be registered for follow-up and monitoring.

### 7.2. Solid infectious waste spills (e.g., a waste bin or sharps box is spilled)

7.2.1. Evacuate the area around the spill and cordon off the area.

7.2.2. Prevent further spill, if relevant.

7.2.3. Do not touch or step on the waste.

7.2.4. Wear gloves. Other PPE is probably not needed and obtaining it will delay cleanup

7.2.5. Using tongs, a dustpan and brush or other suitable tools, clear up the spilled waste. A magnet can be useful for picking up spilled needles from a needle or hub cutter.

7.2.6. If possible, return it to the original container. Otherwise, it should be collected in the most appropriate container that is readily available. It is better to use a plastic bag of the wrong color than to delay the cleanup.

7.2.7. Once the waste has been picked up, wash and disinfect the floor according to normal procedures.

7.2.8. Once the spill has been disinfected, ensure that the waste is packaged and labeled appropriately. For example, if a black plastic bag was used, place it inside a bag of the correct color. If it was necessary to put sharps into a plastic bag, place it in a cardboard box or other puncture-proof container.

7.2.9. Wash and disinfect the tools that were used in the cleanup.

7.2.10. Wash and disinfect hands thoroughly.

### **7.3. Spot cleaning of small liquid spills**

7.3.1. Wipe up the spill with disposable paper towels. Pour alcohol on a paper towel or cloth and wipe the area.

7.3.2. Discard all contaminated materials, including the gloves in the waste container for infectious medical waste.

7.3.3. Wash and disinfect hands thoroughly.

### **7.4. Cleaning after larger liquid spill**

7.4.1. Use an appropriate spill kit.

7.4.2. Wipe up the spill with disposable paper towels. Pour alcohol on a paper towel or cloth and wipe the area.

7.4.3. Use absorbent material to absorb the blood and/or body substances.

7.4.4. Use dustpan and scraper to collect the absorbent materials and spill.\

7.4.5. Remember that absorbed materials have the same properties and hazards as the original spilled materials.

7.4.6. Dispose of all collected material into the containers for infectious medical waste.

7.4.7. Wipe the area with damp paper towel.

7.4.8. Mop the area with a detergent solution.

7.4.9. Wipe the site with disposable towels soaked in a solution of 1% (10,000 ppm) available chlorine.

7.4.10. Clean and disinfect pan, scraper, mop and bucket.

7.4.11. Dispose of gloves and paper towels (without chlorine) into the container for infectious medical waste.

7.4.12. Dispose of paper towels soaked in chlorine solution into the bin for normal waste (as chlorine can damage autoclave for treatment of medical waste).

7.4.13. Clean and disinfect re-usable personal protection equipment immediately after use.

7.4.14. Wash and disinfect hands thoroughly.

7.4.15. The spill kit is re-stocked and returned immediately after the cleaning.

## **8. Reporting and Recordkeeping**

When the contaminated area has been cleaned, complete the Incident Reporting Form (Doc 308), providing the following details:

- Detailed description of the incident
- Cause of the incident
- When and where it happened
- Who was involved
- How the spill was handled

*Source: fhi360, 2010*



## Annex-8: Sample incident/accident reporting form

Date and time of incident:

Location of incident:

Report completed by:

Date of report:

Staff involved in the incident:

**First take appropriate actions to protect the health and wellbeing of yourself and coworkers.**

Once the situation is under control, report the situation to a supervisor/ lab director and fill out this form as completely as possible. A duplicate copy should be maintained in a centralized location.

General description of the incident. Check type and provide further description in space below.

spill       needlestick injury       other injury       fall

breakage       other (explain below)

Was any one injured in the incident?       yes       no

If yes, describe who, the injury and action taken:

Was there any exposure to blood or body fluids?       yes       no

If yes, describe damage and action taken:

Was any equipment damaged?       yes       no

If yes, describe damage and action taken:

Follow up required:

Person responsible: By when:

Safety Officer Name    Supervisor Name    Safety Officer Signature    Supervisor Signature    Date signed  
Date signed

Source: fhi360, 2010

## Annex-9: Facility Health-care Waste Management Plan – Guidance

Note: This guidance document is provided as a template and must be customized to accommodate facility specific procedures and terminology.

### 1. Purpose

This document describes what is required when developing the health-care facility's waste management plan.

### 2. Scope

Wastes generated at health-care facilities have the potential to cause harm if not managed correctly. The risk originates from waste that may be hazardous due to infectious agents, heavy metals (such as mercury), radioactivity (from oncology treatments), as well as redundant and expired pharmaceuticals. General waste, which includes the waste produced from activities in the kitchen, in offices and from other nonhazardous sources, may be safely minimized by recycling and reuse and the residual amount disposed of by landfilling. If risk waste and non-risk waste (general waste) are combined, they must be treated as risk waste, thus larger volumes of waste than necessary are submitted for treatment, which may overload the treatment capacity, leading to stockpiling of untreated risk waste. Waste that is incorrectly segregated leads to increased costs of waste management.

There is an opportunity to reduce risk and costs by managing waste effectively. For waste to be managed, it must be measured. General waste should comprise 70-80% of the facility's waste stream. If the figure is less, this usually means that nonhazardous waste is being discarded with hazardous waste. It is much more expensive to treat waste before disposal than to manage it as general waste. Squandering financial resources on inappropriate waste management will result in less to spend on helping people to live healthy lives.

The health-care facility's waste management plan should integrate all aspects of managing waste, from avoidance and minimization, proper segregation and containment, safe handling, storage and transport, to treatment and disposal. It should clearly define roles and responsibilities of staff, guiding principles, as well as the requirements for training and awareness. Reference to the legal

requirements should be made to ensure compliance is established and standards maintained. The allocation of resources also needs to be set out, in terms of finances, time, equipment and personnel.

### 3. Definitions

**Duty of care** — do no harm to people or the environment by considering the impact from cradle to grave.

**Green procurement** — minimize waste by specifying packaging requirements, take-back policies, just-in-time buying to avoid waste from expired products, substitution of hazardous items/constituents, etc. This is crucial to implementing the Waste Hierarchy.

**Measure to manage** — you need to know how much waste you make to control it. Precautionary principle — if the hazard is unknown, presume the worst.

Proximity principle — reduce the risk from transport by managing wastes as close to the source as possible, within reason, and ensuring that the best practicable option is considered.

**Separation at source** — to ensure that hazardous and nonhazardous wastes are separated, as well as those that can be recycled/reused.

**Waste hierarchy** — waste generation is avoided where possible; minimized by recycling, reusing, recovering, refurbishing, etc.; treated to reduce the risk; and only the smallest residue incinerated or disposed of to landfill.

### 4. Responsibilities

Every member of the facility is responsible for the waste they generate; however, certain personnel will have specific waste management tasks and responsibilities assigned to them.

4.1 Facility manager – overall responsibility and accountability for waste generated and managed on site, as well as for transport from the facility for treatment and/or disposal off-site. The manager is also responsible for ensuring that sufficient resources are allocated to waste management to ensure compliance with legal and other requirements.

4.2. Facility management and supervisors – responsible for checking that appropriate standards are set and maintained on a daily basis in their areas and ensuring that problems are resolved.

4.3. Waste generators – ensure that only they handle the waste and ensure that it is properly segregated at the source and suitably contained to reduce risk of exposure to others.

4.4. Waste handlers – ensure that waste in the intermediate storage areas is properly segregated, contained and labeled. Any problems noted must be immediately brought to the attention of the responsible person in that area.

4.5. Waste management officers – responsible for ensuring that waste is managed according to legal and other requirements, checking that standards are maintained, that everyone is aware of these requirements, that relevant personnel are appropriately trained to safely deal with waste in their areas and that all necessary data are recorded and transmitted to the waste management committee and regulatory authorities.

4.6. Waste management committee – comprised of representatives from senior management, those who generate waste, waste handlers, infection control, procurement and stores, catering, long-term or resident contractors and waste management service providers. This committee should meet monthly to discuss the key performance indicators (e.g., volume of waste generated, hazardous versus general waste ratio, incidents, audit findings, etc.) and to plan awareness programs and other initiatives to improve compliance with legal and other requirements. For smaller facilities, this committee can be the infection control/safety or health (and environmental) committee.

4.7. Contractors – ensure that their staff are properly aware of and trained to comply with waste management requirements, routinely checking to ensure standards are maintained.

## **5. Materials and Equipment: None**

## **6. Hazards and Safety Concerns: None**

## **7. Procedures**

### **7.1. Contents of the plan**

The facility's waste management plan should be drafted by a team, which becomes the waste management committee. The plan should include at least the following items:

**Definitions** – including waste streams, categories, classifications, etc. See Glossary of Terms.

Duties and responsibilities for each category of personnel generating and/or involved in managing health-care waste.

Assessment of current state of waste management activities. Refer to Doc 203: Healthcare Waste Management Audit Procedures – Guidance.

Implementation plan – a detailed plan and timetable outlining the initial stages of the implementation.

Resources (people, equipment and budget) required annually to implement the plan. Refer to Doc 401: Health-care Waste Management Budget Planning – Guidance.

Training requirements – including a matrix (departments, categories of personnel, training requirements, frequency of training, internal and external training service providers), training records. Refer to Doc 301: Health-care Waste Management Training – Guidance. Can include a schedule of themes for the year, with resources (pamphlets, posters, electronic information, presentations, etc.) to raise awareness of waste-related issues that will help to improve waste management in the facility. The resources used will vary with the audience targeted, as determined by facility management. Simple, clear messages are essential, preferably using pictures and photos to convey the information.

Documentation – A file containing all the waste management documentation (procedures, training and awareness, signage, contractors, authorizations, etc.); details of waste storage, collection, transport, treatment and disposal; a site map highlighting the storage areas and other relevant locations; compliance requirements; as well as auditing and inspection procedures and schedules.

Work instruction posters showing waste management requirements at strategic and specific locations for specific waste streams, and how to ensure proper segregation, correct containment and compliance with handling and storage requirements. Facility management should procure posters appropriate for their facility.

### **Incident management and reporting**

- Procedures and associated documentation (such as incident registers, reports, follow-up audits, and work instructions) for hazardous spills (including mercury, radioactivity, etc.); incident analysis and trend reporting, etc. Refer to Doc 304: Biological Spill Clean-Up – SOP; Doc 308: Incident Reporting Form; Doc 309: Incident Log.
- Emergency response, including desktop and live simulations to test awareness and compliance.
- Contingency plans for dealing with emergency or abnormal situations, such as an incident that causes a surge of waste that could exceed the facility's capacity. Examples include:
  - Mass immunizations
  - Outbreak of infectious disease
  - Mass casualties from disasters or other major incidents
  - Breakdown of the treatment/disposal facility or the associated transportation system, which may lead to the requirement for additional storage of waste.

Targets and strategies for reaching them, communicating progress and plans for continuous improvement. Some targets might include:

- Reducing the number of incidents and injuries related to health-care risk waste management
- Reducing the environmental impact of waste treatment technologies
- Reducing the amount and toxicity of waste year by year
- Improving recycling/reuse rates

7.2. Steps for developing the plan (see Attachment 9.2 for a print-ready version) Commit to act. Secure approval from senior management to properly manage waste.

- Convene a committee. Require that all departments appoint representatives to serve on the committee but keep the team small enough to be manageable.
- Agree on major policy points. Ensure that the entire committee agrees on the need to improve health and safety of personnel and are committed to using alternatives to incineration, phasing out mercury, and preventing illegal dumping, among other points.
- Adopt UNDP GEF Policy as the draft policy for first year (refer to Emmanuel [2009]: Elements of a Model Facility Policy on Healthcare Waste Management).
- Allocate a preliminary budget. Assess personnel and equipment costs required to create the waste management system and to operate and maintain it.
- Identify quick wins. Identify some actions that will make a big impact quickly. For example:
  - Returning expired items, chemical containers, and packaging to the suppliers
  - Using bulk containers to reduce the amount of packaging that becomes waste
  - Purchasing items that are reusable, where possible
- Identifying where waste segregation practices are inadequate, determining the current costs for treatment/disposal, then tracking cost savings once segregation is effective
- Consult with stakeholders. Seek guidance from relevant stakeholders and other experts.
- Undertake a baseline assessment of current waste management practices. Consider using the UNDP/GEF Rapid Assessment Tool (IRAT) to assist with this assessment. (<http://gefmedwaste.org/downloads/I-AT%20May%202009%20UNDP%20GEF%20Project.xls>)
- Establish a record of the quantities of hazardous and general waste generated as well as their treatment (recycled, treated, landfilled) calculated monthly and summarized annually.
- Decide on waste management options for each waste stream:
  - Create/update onsite storage/treatment facilities.
  - Explore opportunities to avoid and minimize waste where possible, ensuring that procurement and stores personnel are involved in the process.
  - If needed, contract with service providers for off-site transport, treatment, and disposal.
- Create a detailed implementation plan including time frames, resources (financial, people, time, and equipment), and details of deliverables.
- Finalize budget to ensure sufficient resources are allocated.
- Choose a model ward with the best chance of success in which to begin the program:
  - Train, inspire, and motivate all personnel, including relevant contractors.
  - Work closely with the staff to make sure the plan works for them.

- Monitor and correct any inappropriate behavior immediately.
- Recognize and reward initiative and best practice. Do not move on to the next ward until this one is working properly. Learn the lessons and update the plan accordingly.
- Expand throughout the facility, once the model ward is following the plan properly.
- Train personnel in small groups, shortly before the system will be implemented in their workplaces.
- Identify keen personnel and develop them as trainers and mentors.
- Communicate. Ensure that everyone is aware of the procedures and understands their roles and responsibilities. Regularly communicate how the project is progressing and showcase good practices.
- Monitor progress once the plan is rolled out across the whole facility. Set targets to track trends, so you can try to improve year by year.

## **8. Reporting and Recordkeeping**

Reporting the volumes of health-care risk waste generated, treated and disposed is mandatory in many countries. The facility should establish and maintain a waste register (see Attachment 11.1) to record the various waste streams generated, their classification (hazardous/general), along with their fate (such as recycling/reuse, treatment, landfill) and details of any external service providers involved. These figures should be tallied monthly and annually. It should be used for internal reporting, which will help the Facility to track progress in achieving targets.

## **9. Attachments**

Attachment 9.1: Sample Waste Register (complete in kgs per month per waste stream)

For waste to be managed, it must be measured. There is an opportunity to reduce risk and costs by managing waste effectively. This waste register can be generated in an Excel spreadsheet, with the formula included to automatically update the totals as the entries are made. It can be linked to the registers of each of the facility's departments so that a complete site waste register is available. Examples of nonhazardous waste streams include paper, cardboard, various grades of plastic, polystyrene, and food wastes. Other hazardous wastes include electronic and electric goods and components such as computers, monitors, printers, printer cartridges, phones, pagers, and batteries. Lamps, other than the old energy-wasteful incandescent globes, may contain mercury and other hazardous materials, so are classified as hazardous. Do not forget the facility's workshop wastes, many of which are hazardous including waste oils, biocides and herbicides, PCBs from waste oil in old transformers, and asbestos. All the waste streams need to be identified, classified, reviewed for minimization opportunities and, where hazardous, for replacement with alternatives with less potential for harm to people and the environment.

To complete the form, insert the waste stream name in the top, in place of the heading “waste stream 1” e.g., sharps generated in the ward. Go to row 2 and tick the “hazardous” block (it is potentially infectious) and then in row 3 tick the “treated” and “disposal” block, if the sharps container will be treated to disinfect it before it is landfilled. If treatment is undertaken off-site by a service provider, they will dispose of the disinfected waste, so you do not tick the “disposal” block, just the “treatment” block. If the second waste stream is paper and cardboard from an office, insert this name into the “waste stream 2” block. This waste is not hazardous, so tick “general” in row 2 under this column. If the paper is sent off-site for recycling, tick the “recycle” column. If your area has many waste streams, copy this table into a spreadsheet, or print it in landscape format, So, you can insert many columns for each of the waste streams you manage.

Year	Waste Stream 1					Waste Stream 2					Waste Stream 3					Waste Stream 4					
Tick classification	Hazardous			General		Hazardous			General		Hazardous			General		Hazardous			General		
Tick Waste Destination/Fate	recycle	reuse	treat	landfill	sewer	recycle	reuse	treat	landfill	sewer	recycle	reuse	treat	landfill	sewer	recycle	reuse	treat	landfill	sewer	
January																					
February																					
March																					
April																					
May																					
June																					
July																					
August																					
Sept																					
October																					
November																					
December																					
Annual Totals																					

#### Attachment 9.2: Steps for Developing the Health-care Waste Management Plan

- Commit to act. Secure approval from senior management to properly manage waste.
- Convene a committee. Require that all departments appoint representatives to serve on the committee but keep the team small enough to be manageable.
- Agree on major policy points. Ensure that the entire committee agrees on the need to improve health and safety of personnel and are committed to using alternatives to incineration, phasing out mercury, and preventing illegal dumping, among other points.
- Adopt UNDP GEF Policy as the draft policy for first year (refer to Emmanuel [2009]: Elements of a Model Facility Policy on Healthcare Waste Management).



- Allocate a preliminary budget. Assess personnel and equipment costs required to create the waste management system and to operate and maintain it.
- Identify quick wins. Identify some actions that will make a big impact quickly. For example:
  - Returning expired items, chemical containers, and packaging to the suppliers
  - Using bulk containers to reduce the amount of packaging that becomes waste
  - Purchasing items that are reusable, where possible
- Identifying where waste segregation practices are inadequate, determining the current costs for treatment/disposal, then tracking cost savings once segregation is effective
- Consult with stakeholders. Seek guidance from relevant stakeholders and other experts.
- Undertake a baseline assessment of current waste management practices. Consider using the UNDP/GEF Rapid Assessment Tool (IRAT) to assist with this assessment. (<http://gefmedwaste.org/downloads/I-AT%20May%202009%20UNDP%20GEF%20Project.xls>)
- Establish a record of the quantities of hazardous and general waste generated as well as their treatment (recycled, treated, landfilled) calculated monthly and summarized annually.
- Decide on waste management options for each waste stream:
  - Create/update onsite storage/treatment facilities.
  - Explore opportunities to avoid and minimize waste where possible, ensuring that procurement and stores personnel are involved in the process.
  - If needed, contract with service providers for off-site transport, treatment, and disposal.
- Create a detailed implementation plan including time frames, resources (financial, people, time, and equipment), and details of deliverables.
- Finalize budget to ensure sufficient resources are allocated.
- Choose a model ward with the best chance of success in which to begin the program:
  - Train, inspire, and motivate all personnel, including relevant contractors.
  - Work closely with the staff to make sure the plan works for them.
  - Monitor and correct any inappropriate behavior immediately.
  - Recognize and reward initiative and best practice. Do not move on to the next ward until this one is working properly. Learn the lessons and update the plan accordingly.
  - Expand throughout the facility, once the model ward is following the plan properly.
  - Train personnel in small groups, shortly before the system will be implemented in their workplaces.
  - Identify keen personnel and develop them as trainers and mentors.
- Communicate. Ensure that everyone is aware of the procedures and understands their roles and responsibilities. Regularly communicate how the project is progressing and showcase good practices.
- Monitor progress once the plan is rolled out across the whole facility. Set targets to track trends, so you can try to improve year by year.

Source: fhi360, 2010

## Annex-10: Sequence for putting on PPE during COVID 19 waste handling

### SEQUENCE FOR PUTTING ON PERSONAL PROTECTIVE EQUIPMENT (PPE)

The type of PPE used will vary based on the level of precautions required, such as standard and contact, droplet or airborne infection isolation precautions. The procedure for putting on and removing PPE should be tailored to the specific type of PPE.

#### 1. GOWN

- Fully cover torso from neck to knees, arms to end of wrists, and wrap around the back
- Fasten in back of neck and waist



---

#### 2. MASK OR RESPIRATOR

- Secure ties or elastic bands at middle of head and neck
- Fit flexible band to nose bridge
- Fit snug to face and below chin
- Fit-check respirator



---

#### 3. GOGGLES OR FACE SHIELD

- Place over face and eyes and adjust to fit



---

#### 4. GLOVES

- Extend to cover wrist of isolation gown



### USE SAFE WORK PRACTICES TO PROTECT YOURSELF AND LIMIT THE SPREAD OF CONTAMINATION

- Keep hands away from face
- Limit surfaces touched
- Change gloves when torn or heavily contaminated
- Perform hand hygiene



## Annex-11: Sequence for removing PPE after COVID 19 waste handling

### HOW TO SAFELY REMOVE PERSONAL PROTECTIVE EQUIPMENT (PPE) EXAMPLE 1

There are a variety of ways to safely remove PPE without contaminating your clothing, skin, or mucous membranes with potentially infectious materials. Here is one example. **Remove all PPE before exiting the patient room** except a respirator, if worn. Remove the respirator **after** leaving the patient room and closing the door. Remove PPE in the following sequence:

#### 1. GLOVES

- Outside of gloves are contaminated!
- If your hands get contaminated during glove removal, immediately wash your hands or use an alcohol-based hand sanitizer
- Using a gloved hand, grasp the palm area of the other gloved hand and peel off first glove
- Hold removed glove in gloved hand
- Slide fingers of ungloved hand under remaining glove at wrist and peel off second glove over first glove
- Discard gloves in an infectious\* waste container



#### 2. GOGGLES OR FACE SHIELD

- Outside of goggles or face shield are contaminated!
- If your hands get contaminated during goggle or face shield removal, immediately wash your hands or use an alcohol-based hand sanitizer
- Remove goggles or face shield from the back by lifting head band or ear pieces
- If the item is reusable, place in designated receptacle for reprocessing. Otherwise, discard in an infectious\* waste container



#### 3. GOWN

- Gown front and sleeves are contaminated!
- If your hands get contaminated during gown removal, immediately wash your hands or use an alcohol-based hand sanitizer
- Unfasten gown ties, taking care that sleeves don't contact your body when reaching for ties
- Pull gown away from neck and shoulders, touching inside of gown only
- Turn gown inside out
- Fold or roll into a bundle and discard in an infectious\* waste container



#### 4. MASK OR RESPIRATOR

- Front of mask/respirator is contaminated — DO NOT TOUCH!
- If your hands get contaminated during mask/respirator removal, immediately wash your hands or use an alcohol-based hand sanitizer
- Grasp bottom ties or elastics of the mask/respirator, then the ones at the top, and remove without touching the front
- Discard in an infectious\* waste container

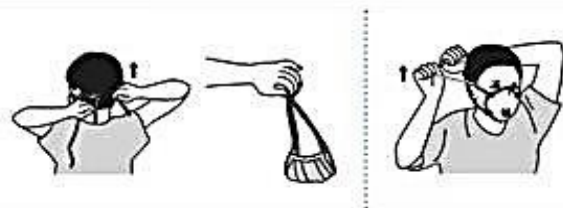

#### 5. WASH HANDS OR USE AN ALCOHOL-BASED HAND SANITIZER IMMEDIATELY AFTER REMOVING ALL PPE

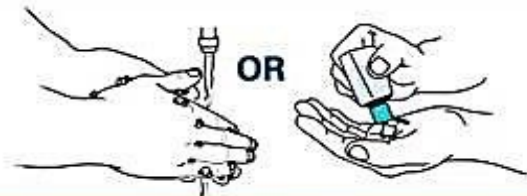

\* An infectious waste container is used to dispose of PPE that is potentially contaminated with Ebola virus.

**PERFORM HAND HYGIENE BETWEEN STEPS IF HANDS BECOME CONTAMINATED AND IMMEDIATELY AFTER REMOVING ALL PPE**



## References

Basel Convention on the Control of the Trans-boundary Movements of Hazardous Wastes and Their Disposal, 1989

CDC Public health service guidelines for the management of health-care worker exposures to HIV and recommendations for post exposure prophylaxis, 1998.

Centre for Disease Control and Prevention: “Handwashing: Clean Hands Save Lives”  
<http://www.cdc.gov/handwashing/>

Health Care without Harm, Health care waste management: corona virus updates, 2020; 24 March 2020

IWSA, Waste management during the COVID-19 Pandemic, 2020

Nepal Health-care waste management guideline, 2014, Nigeria, Health-care waste management guideline

Philippines Health-care waste management guideline, 2020

UN. European agreement concerning the international carriage of dangerous goods by road: ADR. Geneva, United Nations.

UNECE (2010). *European agreement concerning the international carriage of dangerous goods by road: ADR* (Economic Commission for Europe). Geneva, United Nations, 2010

UNEP. Guidelines on best available techniques and provisional guidance on best environmental practices, 2006

WHO (2000). Starting health care waste management in medical institutions. Geneva, World Health Organization, 2000

WHO (2007b). Health care waste management – expanded costing analysis tools. Geneva, World Health Organization (<http://www.healthcarewaste.org/resources/documents/?id=218>).

WHO (World Health Organization). Action plan for the development of a national program for sound management of hospital wastes, 1997

WHO (World Health Organization). Guidelines for safe disposal of unwanted pharmaceuticals in and after emergencies. Geneva, World Health Organization, 1999

WHO CEHA (Centre for Environmental Health Activities) (2002). Basic steps in the preparation of health care waste management plans for health care establishments. Geneva, World Health Organization (<http://www.emro.who.int/ceha>).

WHO Guidelines on Hand Hygiene in Health Care, 2009

WHO Water sanitation health. WHO core principles for achieving safe and sustainable management of health-care waste. Geneva, World Health Organization, 2007 (available at [http://www.who.int/water\\_sanitation\\_health/medicalwaste/hcwprinciples/en/index.html](http://www.who.int/water_sanitation_health/medicalwaste/hcwprinciples/en/index.html)).

WHO, Basel Convention, UNEP. Preparation of national health care waste management plans in sub-Saharan countries: guidance manual. Geneva, World Health Organization and United Nations Environment Program, 2005

WHO, Water, sanitation, hygiene and waste management for the COVID-19 virus, 2020

WHO. Injection safety: technical tools: health care waste management assessment tool. Geneva, WHO ([http://www.who.int/injection\\_safety/toolbox/techttools/en/index.html](http://www.who.int/injection_safety/toolbox/techttools/en/index.html)).

WHO. Preparation of national health care waste management plans in sub-Saharan countries: guidance manual. Geneva, World Health Organization and United Nations Environment Program Secretariat of the Basel Convention, 2005 ([http://www.who.int/water\\_sanitation\\_health/medicalwaste/guidmanual/en](http://www.who.int/water_sanitation_health/medicalwaste/guidmanual/en)).

WHO. Safe health care waste management: policy paper. Geneva, World Health Organization, 2004 ([http://www.who.int/water\\_sanitation\\_health/medicalwaste/hcwmpolicy/en/index.html](http://www.who.int/water_sanitation_health/medicalwaste/hcwmpolicy/en/index.html)).

WHO. Water sanitation health: health care waste management rapid assessment tool. Geneva, World Health Organization, 2004 ([http://www.who.int/water\\_sanitation\\_health/medicalwaste/hcwmtool/en/index.html](http://www.who.int/water_sanitation_health/medicalwaste/hcwmtool/en/index.html)).

WHO: Guidance Manual for the Preparation of National Health Care Waste Management Plans in Sub-Saharan Countries

WHO: Guideline for health-care waste management, 2014

WHO: Guidelines for the Safe Use of Wastewater, Excreta, and Greywater, Volume II, Wastewater Use in Agriculture, 2006

WHO: Laboratory Safety Manual, Third Edition, 2004

WHO: Management of waste from hospitals and other health care establishments, 1985

WHO: Practical Guidelines for Infection Control in Health Care Facilities, 2004

WHO: Safe Management of Wastes from Health Care Activities, 1999

WHO: Safe Management of Wastes from Health Care Activities, draft second edition

WHO: WHO core principles for achieving safe and sustainable management of health-care waste. Geneva, World Health Organization, 2007 ([http://www.who.int/water\\_sanitation\\_health/medicalwaste/hcwprinciples/en/index.html](http://www.who.int/water_sanitation_health/medicalwaste/hcwprinciples/en/index.html))



ጤና ሚኒስቴር - ኢትዮጵያ  
MINISTRY OF HEALTH-ETHIOPIA

የዜጎች ጤና ለሃገር ብልጽግና!  
HEALTHIER CITIZENS FOR PROSPEROUS NATION!

# Health Care Waste Management Manual for Ethiopia

April 2021  
Addis Ababa, Ethiopia